



69939

Madison XO-3
ELECTRONIC DARTBOARD

**Owner's Manual
And Game Instructions**

LIMITED-1 YEAR WARRANTY

This Halex product is warranted to be free from defects in workmanship or materials at the time of purchase for a period of 1 (one) year.

Should any evidence of defects appear within the limited warranty period after the date of purchase, Regent Sports will either send replacement parts or advise another course of action. A list of replaceable parts can be found on the parts order page of this manual. Parts not listed on this order form are not replaceable. This warranty covers normal consumer use and does not cover failures, which result from alterations, accidents, misuse, abuse, or neglect.

For prompt warranty service and special offers, please register your Halex product by visiting our website at www.regent-halex.com. Please be sure to visit our website to order additional parts not covered under the warranty, as well as on-line instruction manuals and new product information.

A purchase receipt or other proof of date of purchase will be required before warranty service is performed. Requests for warranty service can be provided by e-mailing the Customer Service Department at Csdartboards@regent-halex.com or by calling customer service at:

877-516-9707 (Toll-Free)

10:30AM to 6:30 PM, EST. (Dec. through Feb.)

10:30 AM to 5:00 PM, EST. (March through November)

Or send request in writing to:

Regent Sports Corporation
45 Ranick Road
Hauppauge, NY 11788
Attn: Halex Customer Service

This warranty gives you specific legal rights and you may have other rights, which vary, from state to state.

Unpacking the Game

Unpack your new dartboard carefully, making sure all parts are included. The following components are included in this set:

- 1 Electronic Dartboard in molded cabinet
- A/C Adapter
- Owner's Manual
- 12 Darts (unassembled)
- Soft tip replacement pack

If you are missing a part or have any questions, please call our Customer Service Department between 10:30 AM and 6:30 PM, EST. at 877-516-9707 (Toll-Free).

Setup / Mounting Instructions

Choose a location to hang the dartboard where there is about 10 feet of open space in front of the board. The “toe-line” should be 7’ 9 1/4” from the face of the dartboard. Since this dartboard is powered with an AC adapter, you may want to mount it close to an electric outlet for convenience.

The mounting holes on this dartboard set are 16” apart so it can be mounted securely on wall studs in your home. Locate a wall stud and place a mark 79 3/4” from the floor. Measure 16” from your first mark (staying level with the first mark) and place the second mark on the wall, which should be over another wall stud (refer to diagram on next page).

Screw 2 mounting screws in the center of the studs using the marks you made as guides. Be sure the screws are level to ensure an accurate playing surface. If not mounting into studs, be sure to use drywall anchors or other securing hardware appropriate to the wall you are using.

Mount the dartboard on the wall by lining up the hang holes on the back with the screws (see diagram below). It may be necessary to adjust the screws until the board fits snugly against the wall. If you want to mount the dartboard even more securely to the wall, you can fasten four screws through the holes located in the catch ring area (the area outside the scoring segments).

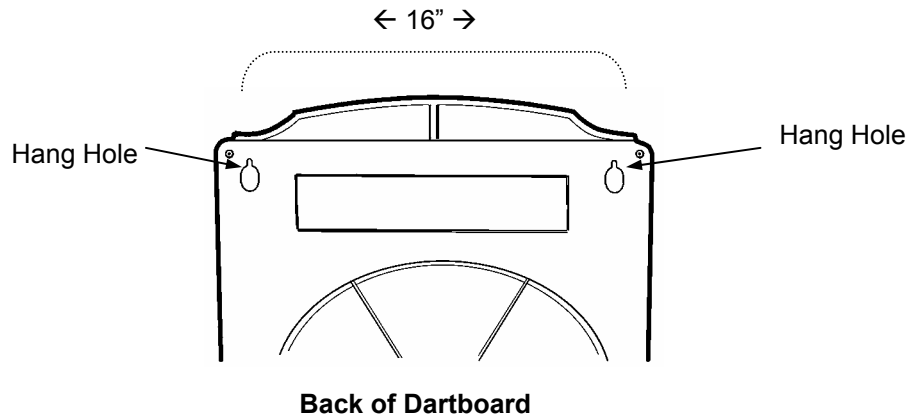

Mounting Instructions (continued)

Center of bullseye should be 5' 8" from the ground.

Plug the A/C adapter into the wall outlet and into the jack at the bottom right of the dartboard and you're ready to play.

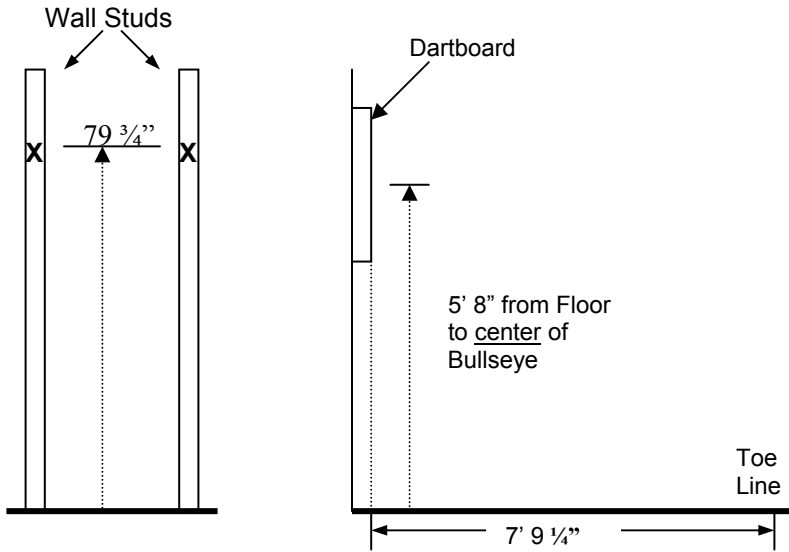

Dartboard Functions

POWER button - Located on the lower right corner of the dartboard (when doors are open). Be sure the AC Adapter is plugged into the jack on the right side of the dartboard. Press the POWER button to turn game on or off.

GAME GUARD button – Press to activate Game Guard Feature

SOUND button – Press continually to set desired volume level or mute.

DOUBLE/MISS button - This button is used to activate the Double In/Double Out and Master Out options for the “01” games. This function is only active when selecting 301, 401, etc. games. The **MISS** feature is active during play of any game. Press button to register a “missed” dart. Player can press when dart lands outside target area so computer registers a thrown dart.

DART-OUT/SCORE button - The dart-out feature is active only during the “01” games (301, 401, etc.). When a player’s score falls below 160, he/she can press the **DART OUT** button to get a suggestion from the dartboard as to the 3 darts needed to finish the game. Note: doubles and triples are indicated with 2 and 3 dashes to the left of the number respectively. The **SCORE** feature allows player to access score not current on display.

BOUNCE OUT button - Decide before play if you want to count darts that do not remain in board (“bounce-outs”) or not. If not, simply press the **BOUNCE OUT** button immediately after a bounce out occurs to deduct the score that registers.

CYBERMATCH button – Press to activate Cybermatch feature where you can play against the computer. Press continually to cycle through the 5 different skill levels. See page 7 for detailed instructions.

PLAYER/PAGE button - This button is used at the start of each game to select the number of players you want to play the game. In addition, this button allows players to see other player scores of not on active display. This dartboard keeps track of scores for up to 8 players.

GAME button - Press to page through the on-screen game menu and select game.

SELECT button - Press to select various difficulty settings for games. Many games contain several difficulty options that can be accessed by pressing this button.

START/HOLD button - This multi-function button is used to:

- **START** the game when all options have been selected.
- **HOLD** to put dartboard in **HOLD** status between rounds to allow player to remove darts from the target area.

RESET button – Press to clear display and reset dartboard to opening sound.

BristleTech™

Playable with Soft Tip or Steel Tip Darts

This dart board utilizes the Halex exclusive state of the art BristleTech target playing surface. BristleTech dartboards allow for both Soft tip and Steel tip dart play. Traditional steel tip dart play combined with the modern convenience of electronic scoring gives you the best of both worlds! The electronic scoring BristleTech playing surface plays and feels just like the natural sisal bristle dartboard.

BristleTech dartboards will provide years of durability and enjoyment as well. The synthetic fiber targets are not susceptible to moisture, humidity and volatile temperature conditions. BristleTech dartboards will not give off potent odors or dry out as sisal bristle dartboards can.

BristleTech dartboards are also a great choice for Soft tip dart players. The BristleTech playing surface provides a smooth quiet dart playing experience- The way the sport was meant to be played! No longer will you experience unpleasant crashing sounds from darts making impact on plastic targets. Additionally, there are no small holes in the BristleTech playing surface. Darts have the maximum amount of surface area to strike upon. This minimizes the chances of deflections and bounce outs.

Please use very special caution when playing with darts (especially steel tip darts.) The steel tip points are sharp and can cause harm. Dart play should always be monitored under close adult supervision.

Electronic Dartboard Operation

1. Press the **POWER** switch to activate dartboard. A short musical introduction is played as the display goes through power-up test.

Press GAME button until desired game is displayed

2. Press **DOUBLE** button (optional) to select starting and/or ending on doubles or Master Out (used only in 301 - 901 games). This is explained in the game rules section.
3. Press **PLAYER** button to select the number of players (1, 2, ... 8). The default setting is 2 players.
4. Press **START/HOLD** button (red) to activate game and begin play.
5. Throw darts
 - The dart indicator display is located above the numbers in the LED displays. The lights indicate the number of darts thrown in the round.
 - When all 3 darts have been thrown, a voice command will indicate "*Remove Darts*" and the score will flash. The darts can now be removed without affecting the electronic scoring. When all darts are removed from the playing surface press the **START** button to go to next player. Voice command will indicate which player is up. Also, the player indicator lights will illuminate to show which player's turn it is.

Display Protective Film

This electronic dartboard may have a clear film over the entire display area and over the button area to prevent scratching during shipping. It is recommended that you remove this film so display is easier to read. To remove, simply lift edge, peel off, and discard.

Game Guard Feature

After the **START** button has been pressed and play has begun, the GAME GUARD feature can be activated. When the button is pressed, all of the keys will 'lock'. When Game Guard is active, a misguided dart hitting a button will not affecting your game. To deactivate the Game Guard, simply press the button again and the keys will unlock.

CyberMatch Feature

This exciting feature allows single player to play against the computer at one of five different levels of skill! **Only 1 player can compete against the CyberMatch competitor at a time.** The CyberMatch feature adds a level of competition to normally routine practice sessions.

To activate the CyberMatch opponent:

1. Select the Game you wish to play
2. Press **CYBERMATCH** button
Select CyberMatch opponent skill level by pressing the **CYBERMATCH** button continually (voice command will indicate level):

Cybermatch Skill Levels

Level 1	(C1)	Professional
Level 2	(C2)	Advanced
Level 3	(C3)	Intermediate
Level 4	(C4)	Novice
Level 5	(C5)	Beginner

3. Press **START** to begin play

When play begins:

The 'human' player throws first. After 3 darts are thrown, go to the board to take darts out and press **START** to change to the next player (CyberMatch). Watch as the CyberMatch opponent's dart scores are registered on the display. After the CyberMatch opponent completes his round, the board will **automatically reset** for the "human" player. Play continues until one player wins. **Good luck!**

Caring for your Electronic Dartboard

1. **Do not use excessive force when throwing darts.** Throwing darts too hard will cause frequent tip breakage and cause excess wear on the board.
2. **Turn darts clockwise as you pull them from the board.** This makes it easier to remove darts and extends the life of the tips.
3. If you need to replace your AC adapter, **use only a genuine Halex AC adapter (available directly from Halex) for this dartboard.** Use of a non-Halex AC adapter may cause electrical shock, fire, and damage to the electronic circuits and will void your warranty.
4. **Do not spill liquids on the dartboard.** Do not use spray cleaners, cleaners that contain ammonia or other harsh chemicals, as they may cause damage.

Accessory Storage

Dart holders and spare tip compartments are located on the inside doors. The spare tip compartments open for easy access. Refer to diagram below.

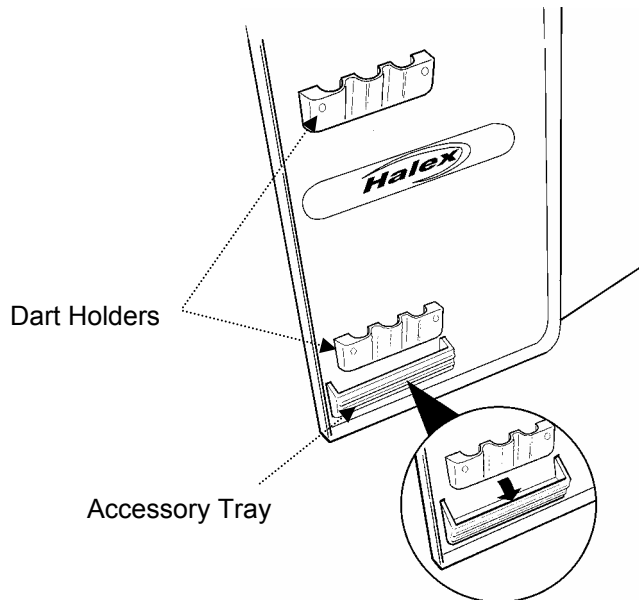

Game Rules

The **Madison** electronic dartboard is loaded with games and options. The rules for each game are detailed below in the order they appear on the LED display when paging through the games. An illustration of the LED displays is indicated next to the game description for your reference. Please note the characters may appear slightly different than illustrated here.

301

This popular tournament and pub game is played by subtracting each dart from the starting total until the player reaches exactly 0 (zero). If a player goes past zero it is considered a “*Bust*” and the score returns to where it was at the start of that round. For example, if a player needs a 32 to finish the game and he/she hits a 20, 8, and 10 (totals 38), the score goes back to 32 for the next round.

In playing the game, the double in / double out option can be chosen (double out is the most widely used option). Simply press the “DOUBLE” button to change this setting. LED indicators will display your current setting:

- **Double In** - A double must be hit before points are subtracted from the total. In other words, a player’s scoring does not begin until a double is hit.
- **Double Out** - A double must be hit to end the game. This means that an even number is necessary to finish the game.
- **Double In and Double Out** - A double is required to start and end scoring of the game by each player.
- **Master Out** - A double or triple is required to finish the game.

Dart-Out Feature (“01” games only)

This electronic dartboard has a special “**Dart Out**” feature. When a player requires less than 160 to reach zero, the estimate feature becomes active. The player can press the **DART OUT** button to view the darts necessary to throw to finish the game (reach zero exactly). Doubles and triples are indicated with 2 or 3 lines to the left of each number respectively.

Adjustable Difficulty Settings for 301 include 401, 501, 601, 701, 801, and 901. To change to these more difficult settings, simply press the SELECT button. Each option is played exactly as outlined for 301 with the exception of the starting total; 401 has starting total of 401 points; 501 has starting total of 501 points and so on up to 901.

CRICKET

Cricket is a strategic game for accomplished players and beginners alike. Players throw for numbers best suited for them and can force opponents to throw for numbers not as suitable for them. The object of Cricket is to “close” all of the appropriate numbers before one’s opponent while racking up the highest number of points.

Only the numbers 15 through 20 and the inner/outer bullseye are used. Each player must hit a number 3 times to “open” that segment for scoring. A player is then awarded the number of points of the “open” segment each time he/she throws a dart that lands in that segment, provided their opponent has not closed that segment. Hitting the double ring counts as two hits, and the triple ring counts as 3 hits.

Numbers can be opened or closed in any order. A number is “closed” when the other player(s) hit the open segment 3 times. Once a number has been “closed”, any player for the remainder of the game can no longer score on it.

Winning - The side closing all the numbers first and accumulating the highest point total is the winner. If a player “closes” all numbers first but is behind in points, he/she must continue to score on the “open” numbers. If the player does not make up the point deficit before the opposing player(s) “closes” all the numbers, the opposing side wins. Play continues until all segments are closed - the winner is the player with the highest score.

Cricket Scoring Display

This dartboard utilizes a dedicated scoreboard that keeps track of each player’s segment status when playing Cricket. The Cricket Scoring display on this dartboard utilizes individual LED’s to track ‘marks’. When Cricket is selected, the lights on the Cricket scoreboard are not lit – they will illuminate as ‘marks’ are scored. There are 3 separate lights within each number (15 through 20 and bullseye). During play, one of the status lights will turn on as a segment is hit. If a double or triple of an active number is hit, 2 or 3 lights will turn on respectively.

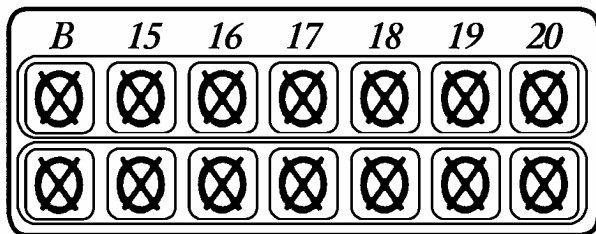

NO-SCORE CRICKET

(Press SELECT button when **Cricket** is displayed)

Same rules as standard Cricket except there is no point scoring. The object of this version is to be the first to simply “close” all the appropriate numbers (15 through 20 and the bullseye).

CUT-THROAT CRICKET

Same basic rules as standard Cricket except once scoring begins, points are added to your opponent(s) total. The object of this game is to end up with the fewest points. This variation of Cricket offers a different psychology to the players. Rather than adding to your own score and helping your own cause as in standard Cricket, Cut-Throat offers the benefit of racking up points for your opponent(s), digging him in a deeper hole. Competitive players will love this variation!

SCRAM

(For 2 players only)

This game is a variation of Cricket. The game consists of two rounds. The players have a different objective in each round. In round 1, player 1 tries to “close” (score 3 hits in each segment - 15 to 20 and bullseye). During this time, player 2 attempts to rack up as many points in the segments that the other player has not yet closed. Once player 1 has closed all segments, round 1 is complete. In round 2, each player’s roles are reversed. Now, player 2 tries to close all the segments while player 1 goes for points.

The game is over when round 2 is complete (player 2 closes all segments). The player with the highest point total is the winner.

ENGLISH CRICKET

(For 2 players only)

This game is another variation of Cricket that requires precision dart throwing. The game consists of two rounds. The players have a different objective in each round. During the first round, player 2 attempts to throw bullseyes – with the objective of needing 9 to complete round 1. Double bull (red center) counts as 2 scores. Any throw that does not hit bullseye is credited to player 1’s point total. For example, if player 2 throws a 20, a single bullseye, and a 7 during his/her turn, player 2 will have one bullseye subtracted from the 9 needed, and 27 points will be credited to player 1’s point total. Player 2 must exhibit accurate bullseye dart throwing!

Meanwhile, player 1 attempts to score as many points as possible during this first round. Doubles and triples count 2x and 3x their respective values. However, to score points, player 1 must score over 40 points in each turn (3 throws) to amass points against player 2. Only those points over 40 are counted toward the cumulative score. Player 1 must also exhibit precision dart throwing and avoid hitting any bullseyes during this first round because any hits scored by player 1 in the bullseye area will be subtracted from player 2’s needed total of 9 bullseyes.

Once player 2 reaches the objective of getting 9 bullseyes, the roles are reversed for round two.

COUNT-UP

The object of this game is to be the first player to reach the specified point total. Point total is specified when the game is selected. Each player attempts to score as many points as possible per round. Doubles and triples count 2 or 3 times the numerical value of each segment. For example a dart that lands in the triple 20 segment is scored as 60 points. The cumulative scores for each player will be displayed in the LED display as the game progresses.

Adjustable Difficulty Settings for Count-Up include 400, 500, 600, 700, 800, 900, and 999. To change to these more difficult settings, simply press the SELECT button. Each option is played exactly as outlined above with the exception of the total necessary to win the game. For example, in Count-Up 500, the first player to reach 500 points is the winner.

HIGH SCORE

The rules for this competitive game are simple - Rack up the most points in three rounds (nine darts) to win. Doubles and triples count as 2x and 3x that segment's score respectively.

Adjustable Difficulty Settings for High Score include 4 rounds, 5 rounds, ... 14 rounds. Each option is played exactly as outlined above with the exception of the number of rounds in the game. For example, in High Score 7 rounds, the player with the most points after 7 rounds is the winner.

ROUND-THE-CLOCK

Each player attempts to score in each number from 1 through 20 and bullseye **in order**. Each player throws 3 darts per turn. If a correct number is hit, he/she tries for the next number in sequence. The first player to reach 20 is the winner. The display will indicate which segment you are shooting for. A player must continue shooting for a segment until it is hit. The display will then indicate the next segment you should shoot for.

There are many difficulty settings available for this game. Each game has the same rules, the differences are detailed as follows:

- **ROUND-THE-CLOCK 5** - Game starts at segment number 5
- **ROUND-THE-CLOCK 10** - Game starts at segment number 10
- **ROUND-THE-CLOCK 15** - Game starts at segment number 15

Since this game does not utilize point scoring, the double and triple rings count as single numbers.

ROUND-THE-CLOCK Double - Player must score a **Double** in each segment from 1 through 20 in order.

- **ROUND-THE-CLOCK Double 5** - Game starts at double segment 5
- **ROUND-THE-CLOCK Double 10** - Game starts at double segment 10
- **ROUND-THE-CLOCK Double 15** - Game starts at double segment 15

ROUND-THE-CLOCK Triple - Player must score a **Triple** in each segment from 1 through 20 in order.

- **ROUND-THE-CLOCK Triple 5** - Game starts at triple segment 5
- **ROUND-THE-CLOCK Triple 10** - Game starts at triple segment 10
- **ROUND-THE-CLOCK Triple 15** - Game starts at triple segment 15

KILLER

This game will really show who your friends are. The game can be played with as few as two players, but the excitement and challenge builds with even more players. To start, each player must select his number by throwing a dart at the target area. The LED display will indicate “SEL” at this point. The number each player gets is his assigned number throughout the game. No two players can have the same number. Once each player has a number, the action starts.

Your first objective is to establish yourself as a “Killer” by hitting the double segment of your number. Once your double is hit, you are a “Killer” for the rest of the game. Now, your objective is to “kill” your opponents by hitting their segment number until all their

“lives” are lost. The last player to remain with lives is declared the winner. It is not uncommon for players to “team up” and go after the better player to knock him out of the game.

Adjustable Difficulty Settings for Killer include 7 lives, 8 lives, ... 14 lives. Each option is played exactly as outlined above with the exception of the number of lives each player has in the game. In addition, for those who really want a challenge, there are three additional difficulty settings: Doubles 3 lives, Doubles 5 lives, and Doubles 7 lives. In these games, you can only “Kill” opponents by scoring doubles in their number segment.

DOUBLE DOWN

Each player starts the game with 40 points. The object is to score as many hits in the active segment of the current round. The first round, the player must throw for the 15 segment. If no 15’s are hit, his score is cut in half. If some 15’s are hit, each 15 (doubles and triples count) is added to the starting total. The next round players throw for the 16 segment and hits are added to the new cumulative point total. Again, if no hits are registered, the point total is cut in half.

Each player throws for the numbers as indicated in the chart below in order (the LED screen will indicate the active segment in which to throw). The player who completes the game with the most points is the winner.

	15	16	D	17	18	T	19	20	B	TOTAL
Player 1										
Player 2										

Any Double

Any Triple

DOUBLE DOWN 41

This game follows similar rules as standard Double Down as described above with two exceptions. First, instead of going from 15 through 20 and bullseye, the sequence is reversed which will be indicated on the LED display. Second, an additional round is included toward the end in which players must attempt to score three hits that add up to 41 points (20, 20, 1; 19, 19, 3; D10, D10, 1: etc.). This “41” round adds an extra level of difficulty to the game. Remember, a player’s score is cut in half if not successful, so the “41” round presents quite a challenge!

	20	19	D	18	17	T	16	15	41	B	TOTAL
Player 1											
Player 2											

Any Double

Any Triple

“41” Round

ALL FIVES

The entire board is in-play for this game (all segments are active). With each round (of 3 darts) each player has to score a total which is divisible by 5. Every “five” counts as one point. For example 10, 10, 5 = 25. Since 25 is divisible by 5 fives, this player scores 5 points (5 x 5 = 25).

If a player throws 3 darts that are not divisible by 5, no points are given. Also, the last dart of each round must land in a segment. If a player throws the third dart and it lands in the catch ring area (or misses the board completely), he earns no points even if the first two darts are divisible by 5. This prevents a player from “tanking” the third throw if his first two are good. The first player to total fifty-one (51) “fives” is the winner. The LED screen will keep track of the point totals.

Adjustable Difficulty Settings for All Fives include 51, 61, 71, 81, and 91. Each option is played exactly as outlined above with the exception of the number of points (or fives) it takes to win the game.

SHANGHAI

Each player must progress around the board from 1 through 20 in order. Players start at number 1 and throw 3 darts. The object is to score the most points possible in each round of 3 darts. Doubles and triples count toward your score. The player with the highest score after completing all twenty segments is the winner.

Adjustable Difficulty Settings for Shanghai include the following options:

- **SHANGHAI 5** - Game starts at segment 5
- **SHANGHAI 10** - Game starts at segment 10
- **SHANGHAI 15** - Game starts at segment 15

In addition, we added **Super Shanghai** as a difficulty option. This game is played exactly as described above except various doubles and triples must be hit as specified by the LED display.

Adjustable Difficulty Settings for Super Shanghai include the following options:

- **SUPER SHANGHAI 5** - Game starts at segment 5
- **SUPER SHANGHAI 10** - Game starts at segment 10
- **SUPER SHANGHAI 15** - Game starts at segment 15

GOLF

This is a dartboard simulation of the game golf (but you don't need clubs to play). The object is to complete a round of 9 through 18 "holes" with the lowest score possible. The Championship "course" consists of all par 3 holes making par 27 for a nine hole round or 54 for a round of 18.

The segments 1 through 18 are used with each number representing a "hole." You must score 3 hits in each hole to move to the next hole. Obviously, double and triples affect your score as they allow you to finish a hole with fewer strokes. For example, throwing a triple on the first shot of a hole it is counted as an "eagle" and that player gets a completes that hole with 1 "stroke."

Note: **The active player continues to throw darts until he "holes out"** (scores 3 hits on the current hole). The voice announcer will indicate the player that is up - listen carefully to avoid shooting out of sequence. By the way, there are no "gimmes" in this game!

FOOTBALL

Strap your helmet on for this game! The first thing necessary is to select each player's "playing field." This can be done by throwing a dart or by manually pressing a segment on the board by each player. This is entirely up to you, but whichever segment is selected becomes your starting point which carries through the bullseye and directly across to the other side of the bullseye (see diagram).

For example, if you select the 20 segment, you start on the double 20 (outer ring) and continue all the way through to the double 3. The "field" is made up of 11 individual segments and must be hit in order. So, keeping with the example above, you must throw darts in the following segments in this order:

Double 20 ... Outer Single 20 ... Triple 20 ... Inner Single 20 ... Outer Bullseye ... Inner Bullseye ... Outer Bullseye ... Inner Single 3 ... Triple 3 ... Outer Single 3 ... and finally a Double 3.

The First player to "score" is the winner. The LED display will keep track of your progress and indicate the segment you need to throw for next.

BASEBALL

This dartboard version of baseball takes a great deal of skill. As in the real game, a complete game consists of 9 innings. Each player throws 3 darts per “inning.” The field is laid out as shown in the diagram.

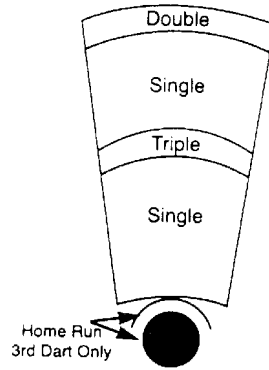

Segment	Result
Singles segments	“Single” - one base
Doubles segment	“Double” - two bases
Triples segment	“Triple” - Three bases
Bullseye	“Home Run” (<i>can only be attempted on third dart of each round</i>)

The object of the game is to score as many runs as possible each inning. The player with the most runs at the end of the game is the winner.

STEEPLECHASE

The object of this game is to be the first player to finish the “race” by being the first to complete the “track.” The track starts at the 20 segment and runs clockwise around the board to the 5 segment and ends with a bullseye. Sounds easy right? What has not yet been specified is that you must hit the inner single segment of each number to get through the course. This is the area between the bullseye and the triples ring. And, as with a real steeplechase, there are obstacles throughout the course to hurdle. The four hurdles are found at the following places:

- 1st fence Triple 13
- 2nd fence Triple 17
- 3rd fence Triple 8
- 4th fence Triple 5

The first player to complete the course and hit the bullseye wins the race.

ELIMINATION

The object of the game is to “Eliminate” your opponents. The rules are very simple. Each player must score higher total points with 3 darts than the opponent before them. Each player starts with 3 lives. If the player fails to score higher total points than the previous opponents score, they lose one life. Tie scores will also result in a lost life. The winner is the last player with lives remaining. Press the **SELECT** button before starting to play with 4 or 5 lives per player.

HORSESHOES

This 2 -player game uses only the 20 and 3 segments to represent the two horseshoe pits. Player 1 will shoot at the 20 segment and Player 2 will shoot at the 3 segment.

Scoring is cumulated per round. First player to score 15 points is the winner.

Scoring for Horseshoes is as follows:

- TRIPLE RING = Ringer 3 points
- DOUBLE RING= Leaner 2 points
- INNER SEGMENT (Small)= 1 point

Scores will only count for the player or team with the most points in that round. For example, if player 1 scores 3 points and player 2 scores 1 point, only player 1 will awarded 3 points for that round. Rounds continue until 15 points are scored.

Adjustable Difficulty Settings for Horseshoes include games from 15- 25 points. Press the **SELECT** button before starting the game for these variations.

BATTLEGROUND

In this 2-player game, the dartboard is a battleground divided into two halves. The first player to hit all of the opposing segments (armies) wins the game. Segments do not have to be hit in order.

Player 1 is the "TOP" army and shoots darts at the bottom sections of the board. Player 1 needs to hit bottom segments (6, 10, 15, 2, 17, 3, 19, 7, 16, 8)

Player 2 is the "BOTTOM" army and shoots for the top section of the dartboard. Player 2 needs to hit top segments (11, 14, 9, 12, 5, 20, 1, 18, 4, 13)

Adjustable difficulty settings are as follows:

BATTLEGROUND DOUBLES:

- Players shoot for double segments only to eliminate opponent's armies

BATTLEGROUND TRIPLES:

- Players shoot for triple segments only to eliminate opponent's armies

BATTLEGROUND with GENERALS

This variation of the game includes one more obstacle to accomplish to win the game. Players must capture the "general" after all segments (armies) have been hit to win the game. One hit on the bullseye will capture the general. Hits to the bullseye will not count if all segments are not first closed.

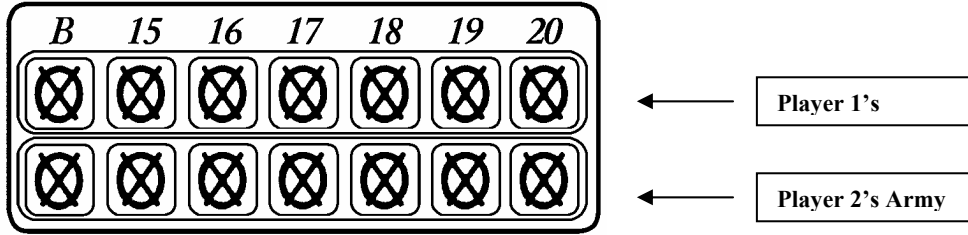

The top cricket scoring display on the dartboard shows player 1's army segments. Player 2's army segments are in the second row. Each time a segment is hit, the corresponding light will shut off. Follow the scoreboard below to keep track of which segments you need to hit to win.

PLAYER 1's ARMY SEGMENTS

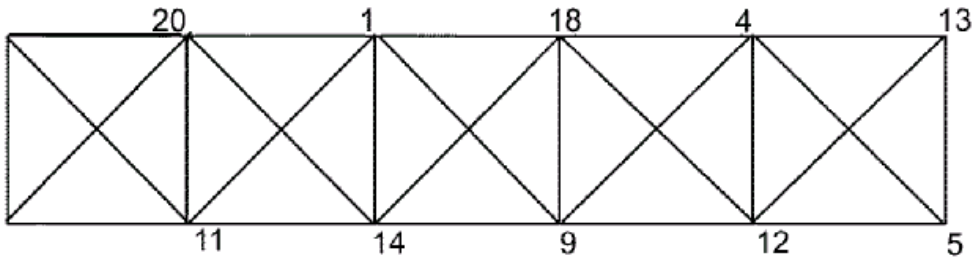

PLAYER 2's ARMY SEGMENTS

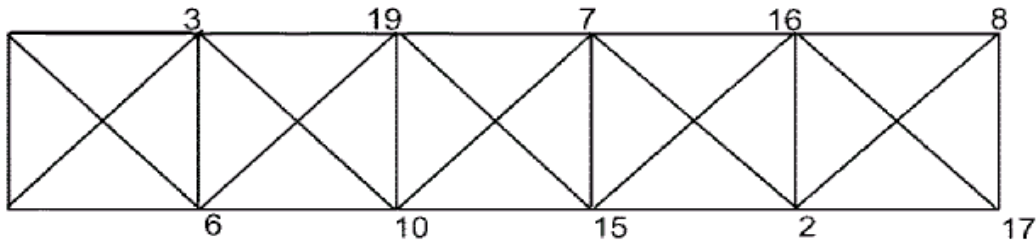

ADVANCED BATTLEGROUND

The rules are the same as standard Battleground except now there are land mines on the battlefield!

Players must be careful to avoid the land mines located in the Triple and Double rings of opponents segment numbers.

Any player that hits a double or triple ring on the opposing teams battlefield will lose an army of his or her own. For example, if player 1 mistakenly hit the triple ring of the “6” segment, they would lose their own army at the “11” segment. A mine can only be set off once in each segment per game.

PAINTBALL

This game is similar to “Battleground” except there is an alternative way to win the battle other than just hitting the opposing teams armies segments. As in the real game of paintball, players can also capture the opposing team’s flag to win the game. To capture the flag, the double bullseye must be hit 2 times to capture the opposing teams flag! Single bullseyes will not count towards the 2 needed to capture the flag. Double bullseyes hit do not have to be scored in the same round and will be tallied during the game. First player to either capture the flag or eliminate the opposing army is the winner.

Adjustable Difficulty Settings

Paintball Doubles Players must either hit 3 double bullseyes to capture the flag or hit double ringed segments to eliminate armies.

Paintball Triples Players must either hit 3 double bullseyes to capture the flag or hit triple ringed segments to eliminate armies.

CAT & MOUSE

This is a very challenging 2-player game that is best suited for players of advanced skill.

One player will play the role of the cat and the other will be the mouse. The object of the game is for the mouse to get back to his hole before being caught by the cat. The mouse starts first from the “20” segment and proceeds counter-clockwise around the dartboard by hitting first the double segment and then the single of each segment. The cat starts back at the “18” segment and proceeds counter clockwise around the dartboard to catch the mouse by hitting doubles only of each segment. If the mouse makes it all the way around the board back to the double 20, the mouse wins the game. If the cat hits the double segment that the mouse is on, the cat has caught the mouse and has won the game.

Game # Code Description

G01	STD	301
G02	CRI	Cricket
G03	scr	Scram
G04	cut	Cut Throat Cricket
G05	ENG	English Cricket
G06	ACR	Advanced Cricket
G07	SHO	Shooter
G08	BSI	Big Six
G09	OUR	Overs
G10	UND	Unders
G11	CUP	Count Up
G12	HSC	High Score
G13	RON	Round The Clock
G14	KIL	Killer
G15	DON	Double Down
G16	F41	Double Down 41
G17	ALL	All Fives
G18	SHI	Shanghai
G19	GOL	Golf
G20	FOT	Football
G21	BAS	Baseball
G22	HOR	Steeplechase
G23	ELM	Elimination
G24	HSE	Horseshoes
G25	BAT	Battleground
G26	ADV	Advanced Battleground
G27	PAI	Paintball
G28	CAT	Cat & Mouse

Game Menu

Note: Press SELECT button to access various difficulty settings and levels

Important Notes

Stuck Segment

Occasionally, a dart will cause a segment to become wedged within the segment separator web. If this happens, all play will be suspended and the LED display will indicate the segment number that is stuck.

To free the segment, simply remove the dart or broken tip from the segment. If the problem is still not solved, try wiggling the segment until it is loose. The game will then resume where it left off.

Darts

This dart board can be used with **Steel tip or Soft tip darts** . The darts included with this dartboard are both steel tip and soft tip style darts. Please use extreme caution when throwing darts. Steel tip darts can be very dangerous if not used with carefully.

Replacement SofTech tips are available through Regent Sports for the Soft tip darts. Additional ordering information can be found in the spare parts section of this manual.

Cleaning your Electronic Dartboard

Your Halex electronic dartboard will provide many hours of competition if cared for properly. Regular dusting of the cabinet is recommended using a damp cloth. A mild detergent can be used if necessary. The use of abrasive cleaners or cleaners that contain ammonia may cause damage and should not be used. Avoid spilling liquid onto the target area since it can result in permanent damage and is not covered by the warranty.

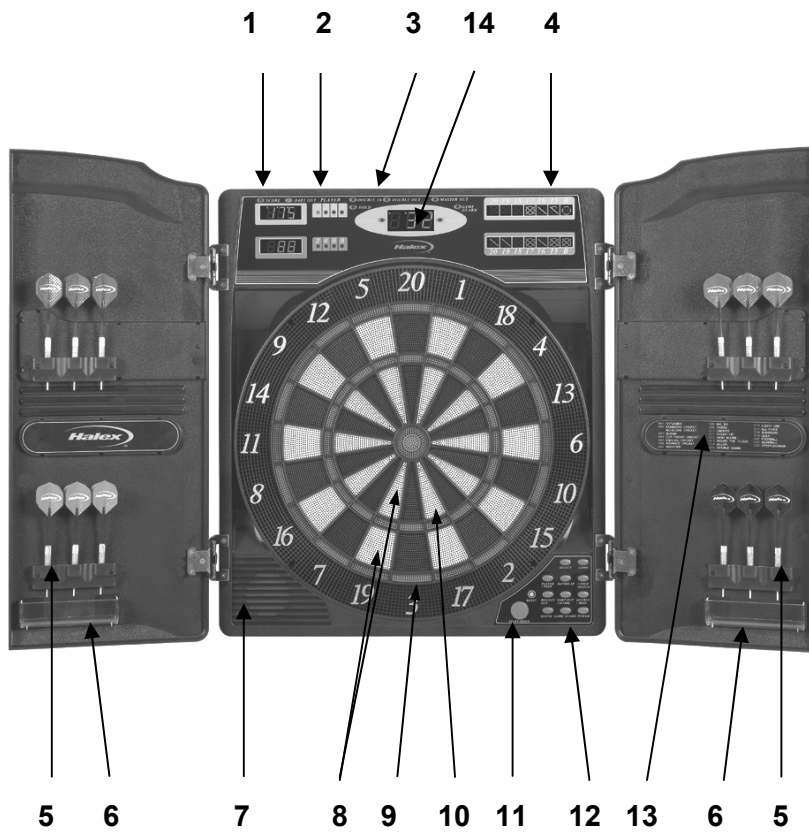

- | | |
|--|----------------------------|
| 1. LED Scoring displays | 8. Singles ring |
| 2. Player indicators | 9. Doubles ring |
| 3. Double In/Out, Master
Out indicators | 10. Triples ring |
| 4. Cricket Scoreboards | 11. Start/Hold button |
| 5. Dart Holders | 12. Control area (buttons) |
| 6. Accessory tray | 13. Game Menu |
| 7. Speaker | 14. Active Score Display |

Accessories / Spare Parts

<u>Item #</u>	<u>Description</u>	<u>Price</u>
100-64675	12 darts with replacement Tips	\$12.95
100-64670	AC Adapter	\$11.95
68950-00	Aluminum Shafts (3 pack)	\$ 4.50
68900-00	Polyester Shafts (3 pack)	\$ 3.50
68835	Deluxe Soft Tip Accessory Kit	\$12.95
68670wal00	Metallic Flights (3 pack). Assorted Styles	\$ 4.50
67200	English-Style brass Soft Tip darts (3 pack) 14 grams	\$ 7.95

Prices include shipping and handling.

To place order:

MasterCard/Visa

Call Halex Customer Service Line at 877-516-9707 (Toll Free) and specify item number. Have your credit card number ready when you place call. Or you can place your order on our website at www.regent-halex.com

Mail

Make check payable to: **Regent Sports Corporation** and send to the following address:

45 Ranick Road
Hauppauge, NY 11788
Attn: Customer Service

Please do not send cash. Please indicate item # on check.

Be sure to check out our web site at:

www.regent-halex.com

• **Parts Ordering** • **Owners Manuals** • **Product Information**

© 2004
Regent Sports Corporation
Hauppauge, New York 11788