

Red Hockey

TABLE
Games
Assembly instructions

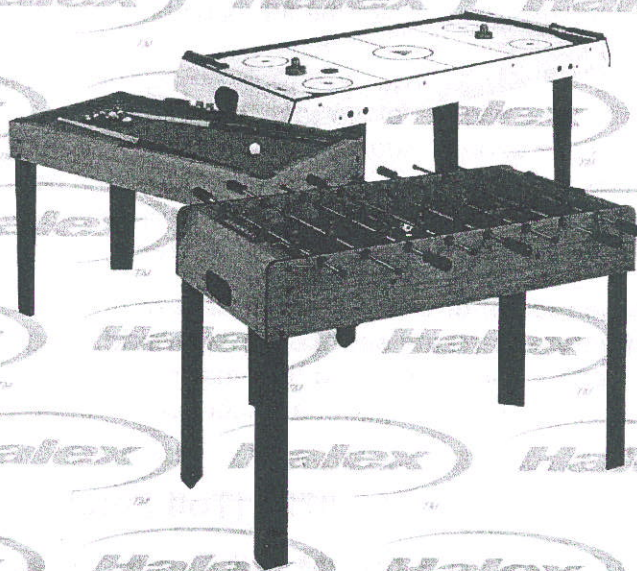

Halex
TM

63556LO

Rod Hockey

Rules of Play

The Object of the Game

The object of Rod Hockey is to be the first player to score 10 goals against the opposing player.

Beginning the Game

Matches begin with the puck placed in the center of the rink, the 2 center-forwards being on their own side. Face off is made by releasing the puck in the center of the middle circle, the 2 center-forwards being in the position above mentioned. Before releasing the puck, be sure opponent is ready.

During Play

Players attempt to pass the puck to their own players, and utilizing the rods, try to score a goal. If the puck becomes stuck on a part of the table that cannot be reached by a hockey player, the puck needs to be picked up and placed in the center for a new face-off. Each player controls his/her own offense and defense during play. The goalie can be controlled for lateral movement to block shots on goal.

Scoring

A goal is scored when the puck enters and drops inside the opponent's goal.

A face-off is required to after each goal is scored.

Winning

The first player to score 10 points is declared the winner.



LIMITED 90 DAY WARRANTY

This Halex product is warranted to be free from defects in workmanship or materials at the time of purchase for a period of 90 (ninety) days. Certain restrictions apply (see below).

Should any evidence of defects appear within the limited warranty period after the date of purchase, Regent Sports will either send replacement parts or advise of another course of action. A list of replaceable parts can be found on the parts order form page of this manual. Parts not listed on this order form are not replaceable. **Table tops, playing surfaces, and main frames are not replaceable.** This warranty covers normal consumer use and does not cover failures, which result from alterations, accidents, misuse, abuse, or neglect.

For prompt warranty service and special offers, please register your Halex product at our customer service center by visiting our website at: www.regent-halex.com. Enter the following unique registration number followed by the item number of your table found on the cover of this manual: 1ZAK7 _____. You must register your product within 30 days of purchase to be eligible for warranty service. Please make sure to visit our website to order additional parts not covered under the warranty, as well as on-line instruction manuals and new product information. You may also order parts by calling our automated voice recognition system at: 877-516-9707 (Toll Free).

A purchase receipt or other proof of date of purchase will be required before warranty service is performed. Requests for warranty service can be provided by e-mailing the customer service department at cstables@regent-halex.com or by calling customer service at:

877-516-9707 (Toll Free)

10:00 AM to 6:00 PM, EST. (Dec. through Jan.)











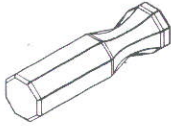
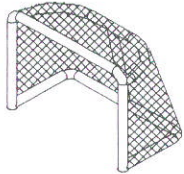





10:00 AM to 5:00 PM, EST. (Feb. through Nov.)



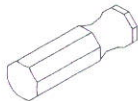
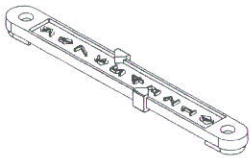
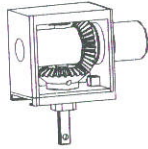

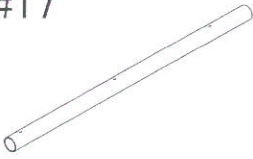
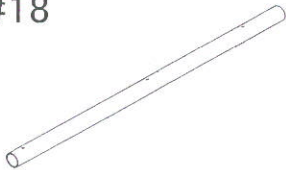
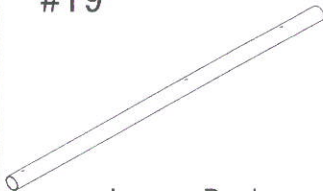
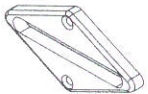

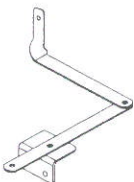

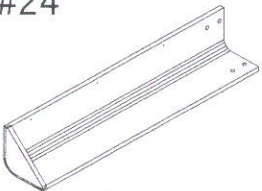

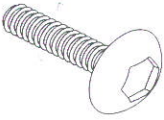
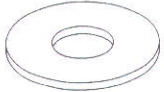

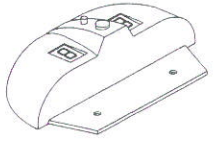

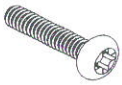

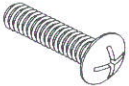

Or send request in writing to:

Regent Sports Corporation
45 Ranick Road
Hauppauge, NY 11788
Attn: Halex Customer Service

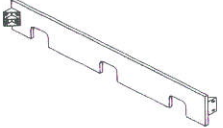
This warranty gives you specific legal rights and you may have other rights that vary from state to state.

63556LO ROD HOCKEY PARTS LIST

<p>#1</p>  <p>Rod Handles 10Pieces</p>	<p>#2</p>  <p>Hockey Goal 2Pieces</p>	<p>#3</p>  <p>Red Short Stick Player 1Pieces</p>	<p>#4</p>  <p>Red Long Stick Player 4Pieces</p>
<p>#5</p>  <p>Red Goalie 1Pieces</p>	<p>#6</p>  <p>Blue Short Stick Player 1Pieces</p>	<p>#7</p>  <p>Blue Long Stick Player 4Pieces</p>	<p>#8</p>  <p>Blue Goalie 1Pieces</p>
<p>#9</p>  <p>Hockey Puck 4Pieces</p>	<p>#10</p>  <p>Rod Bushing 10Pieces</p>	<p>#11</p>  <p>Foam Spacer 10Pieces</p>	<p>#12</p>  <p>Rod Stopper 10Pieces</p>
<p>#13</p>  <p>Goalie Handle 2Pieces</p>	<p>#14</p>  <p>Manual Scorer 2Pieces</p>	<p>#15</p>  <p>Gear Mechanism 10Pieces</p>	<p>#16</p>  <p>Short Rod 4Pieces</p>
<p>#17</p>  <p>Medium Rod A 2Pieces</p>	<p>#18</p>  <p>Medium Rod B 2Pieces</p>	<p>#19</p>  <p>Long Rod 2Pieces</p>	<p>#20</p>  <p>Goalie Cover 2Pieces</p>
<p>#21</p>  <p>Goalie Control A 2Pieces</p>	<p>#22</p>  <p>Goalie Control B 2Pieces</p>	<p>#23</p>  <p>End Leg Panel 2Pieces</p>	<p>#24</p>  <p>Leg 4Pieces</p>

<p>#25</p>  <p>M6 Bolt 16Pieces</p>	<p>#26</p>  <p>M6 Flat Washer 16Pieces</p>	<p>#27</p>  <p>Sticker Sheet 1 Set</p>	<p>#28</p>  <p>Electronic scorer 1 pieces</p>
<p>#29</p>  <p>M3 Round Head Bolt 10Pieces</p>	<p>#30</p>  <p>M3 Bolt 10Pieces</p>	<p>#31</p>  <p>M3 Locking Nut 10Pieces</p>	<p>#32</p>  <p>M4 Bolt 10Pieces</p>
<p>#33</p>  <p>M4 Nut 10Pieces</p>	<p>#34</p>  <p>Round Head Screw 20Pieces</p>	<p>#35</p>  <p>Tool 1Pieces</p>	<p>#36</p>  <p>Round Head Screw 2Pieces</p>
<p>#37</p>  <p>M4 Bolt 10Pieces</p>	<p>#38</p>  <p>M4 Nut 10Pieces</p>	<p>#39</p>  <p>Support Brace 1Pieces</p>	<p>#40</p>  <p>M5 Flat Washer 4 Pieces</p>
<p>#41</p>  <p>Flat Head Screw 6 Pieces</p>	<p>#42</p>  <p>M4 Bolt 2Pieces</p>	<p>#43</p>  <p>Round Head Screw 4Pieces</p>	<p>#44</p>  <p>Flat Head Screw 4 Pieces</p>
<p>#45</p>  <p>M4 Locking Nut 2Pieces</p>			

Step 1- Slide all Gears #15 into tracks on the playing surface. Next slide all Rods through end panels following number order on diagram. Slide Foam Spacer #11 on to each rod. Next attach Rod Stopper #12 to each rod using M4 Bolt #37 and Nut #28. Next attach the rod to the gear using M3 Bolt #30 and Nut #31. Attach Rubber Bushing #10 to each end of the rods. Next attach Handle#1 on to each rod using bolts #32 and Nuts # 33.Next secure the goalie cover #20 to the end panel with the flat head screw #41.

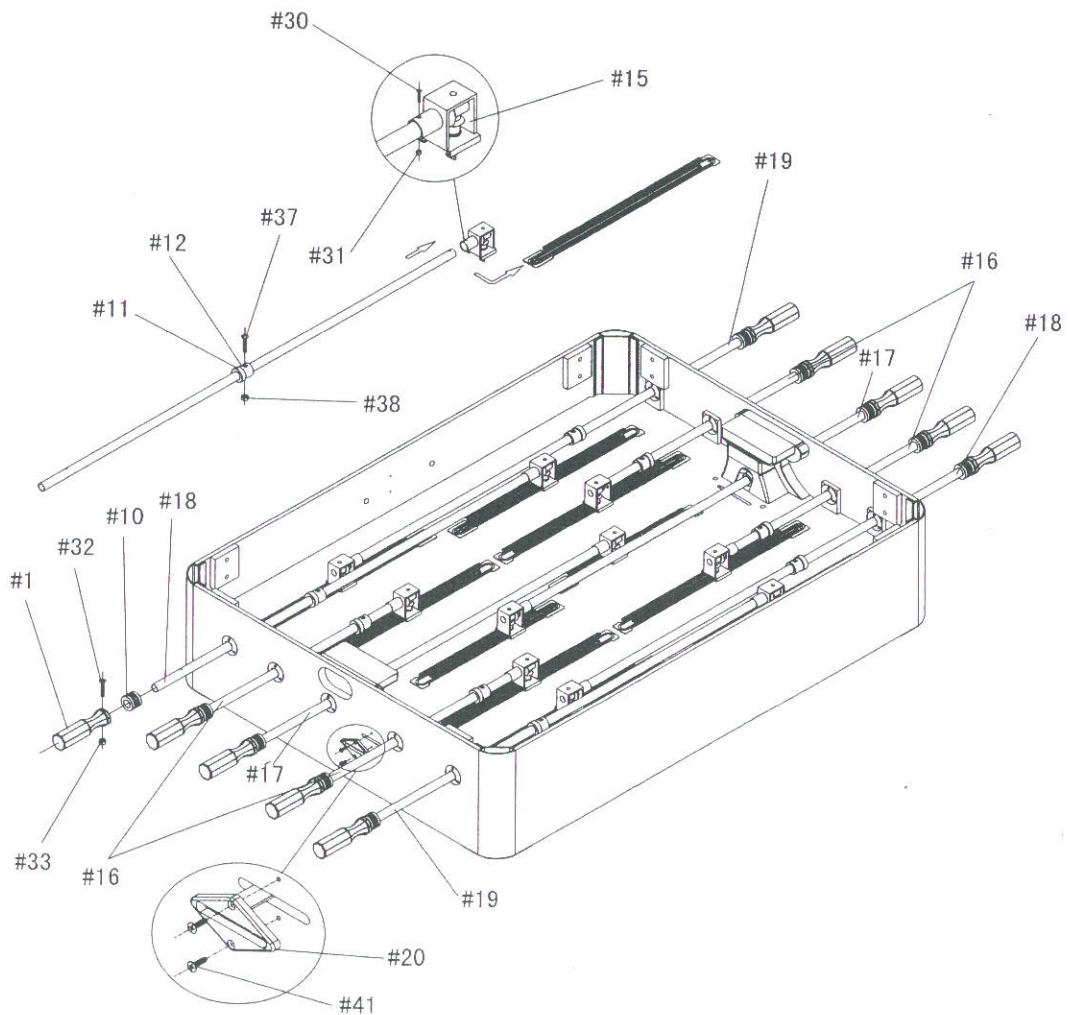

Step 2- Attach Goalie Control B #22 to the end panels using Screws # 43. Next attach goalie control A #21 with goalie control B using M4 bolt #42 and Locking Nut #45. Next attach table Support Brace #39 to the center of the table using Screws #34.

