

TABLE
Games

Assembly instructions



Halex
TM

63545

Should you have a defect or parts issue, please refer to the warranty instructions listed below and contact Regent Sports at our toll free number!!

LIMITED 90 DAY WARRANTY

This Halex product is warranted to be free from defects in workmanship or materials at the time of purchase for a period of 90 (ninety) days. Certain restrictions apply (see below).

Should any evidence of defects appear within the limited warranty period after the date of purchase, Regent Sports will either send replacement parts or advise of another course of action. A list of replaceable parts can be found on the parts order form page of this manual. Parts not listed on this order form are not replaceable. Table tops, playing surfaces, and main frames are not replaceable. This warranty covers normal consumer use and does not cover failures, which result from alterations, accidents, misuse, abuse, or neglect.

For prompt warranty service and special offers, please register your Halex product at our customer service center by visiting our website at: www.regent-halex.com. Enter the following unique registration number followed by the item number of your table found on the cover of this manual: 1ZAK7 _____. You must register your product within 30 days of purchase to be eligible for warranty service. Please make sure to visit our website to order additional parts not covered under the warranty, as well as on-line instruction manuals and new product information. You may also order parts by calling our automated voice recognition system (877) 516-8707.

A purchase receipt or other proof of date of purchase will be required before warranty service is performed. Requests for warranty service can be provided by e-mailing the customer service department at cstables@regent-halex.com or by calling customer service at:

877-516-9707 (Toll Free)

10:00 AM to 6:00 PM, EST. (Dec. through Jan.)

10:00 AM to 5:00 PM, EST. (Feb. through Nov.)

Or send request in writing to:

**Regent Sports Corporation
45 Ranick Road
Hauppauge, NY 11788
Attn: Halex Customer Service**

This warranty gives you specific legal rights and you may have other rights that vary from state to state.

63545















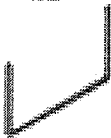
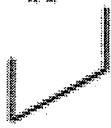
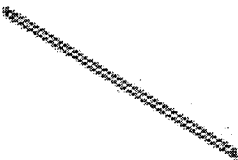
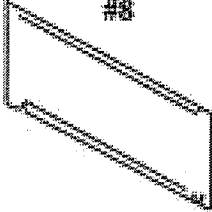



REVISION NOTICE











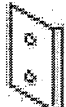

Part #28 (Side Metal Apron) includes 3 pieces with 4 holes and 1 piece with 5 holes. The piece with 5 holes is intended for assembling the storage bag, which can be found in Step 3 of the instructions.

NOTIFICATION DE REVISION

La pièce N° 28 (bordure latérale en métal) compte 3 pièces comportant 4 trous et 1 pièce comportant 5 trous. La pièce à 5 trous sert au montage du sac de rangement qui se trouve à la troisième étape des instructions.

63545 PARTS LIST & ASSEMBLY
Part I. Parts List

<p align="center">#1</p>  <p align="center">TABLE SURFACE 1PC</p>	<p align="center">#2</p>  <p align="center">TABLE SURFACE 1PC</p>	<p align="center">#3</p>  <p align="center">TABLE SURFACE 1PC</p>
<p align="center">#4</p>  <p align="center">TABLE SURFACE 1PC</p>	<p align="center">#5</p>  <p align="center">LARGE U-LEG 2PCS</p>	<p align="center">#6</p>  <p align="center">SMALL U-LEG 2PCS</p>
<p align="center">#7</p>  <p align="center">SUPPORT ARM 4 PCS</p>	<p align="center">#8</p>  <p align="center">LEG BRACE 7" 2PCS</p>	<p align="center">#9</p>  <p align="center">BRACKET 6 PCS</p>
<p align="center">#10</p>  <p align="center">M6 x 10 BOLT 44 PCS</p>	<p align="center">#11</p>  <p align="center">M6 x 50 BOLT 16 PCS</p>	<p align="center">#12</p>  <p align="center">WASHER 16 PCS</p>
<p align="center">#13</p>  <p align="center">WING NUT 16 PCS</p>	<p align="center">#14</p>  <p align="center">SPACER 8 PCS</p>	<p align="center">#15</p>  <p align="center">M3 x 10 SCREW 8 PCS</p>
<p align="center">#16</p>  <p align="center">M4 x 13 SCREW 4 PCS</p>	<p align="center">#17</p>  <p align="center">M4 x 25 SCREW 12 PCS</p>	<p align="center">#18</p>  <p align="center">M4 x 12 SCREW 27 PCS</p>
<p align="center">#19</p>  <p align="center">LARGE LEG BRACKET 4 PCS</p>	<p align="center">#20</p>  <p align="center">SMALL LEG BRACKET 8 PCS</p>	<p align="center">#21</p>  <p align="center">LOCK PIN 2PCS</p>

 #22 BRACKET 2 PCS	 #23 TABLE TENNIS PADDLE 2 PCS	 #24 TABLE TENNIS BALL 3 PCS
 #25 SAFETY STRAP SET 89CM 1 SET	 #26 WHEEL 4 PCS	 #27 FRONT METAL APRON 1.3M 2 PCS
 #28 SIDE METAL APRON 1.25M 4 PCS	 #29 MOLDED PROTECTIVE CORNER 4 PCS	 #30 STORAGE BAG 1 PCS
 #31 TAPE 1 PC	 #32 NET POST 2 PCS	 #33 NET SET 1 PC

Part II. Assembly

STEP 1.

Step 1- Assemble playing surface pieces. Lay the pieces upside down on a clean dry surface. Align inside seams of each section so that the pre-drilled holes line up across from each other. Next attach Bracket # (9) using Bolts # (10).

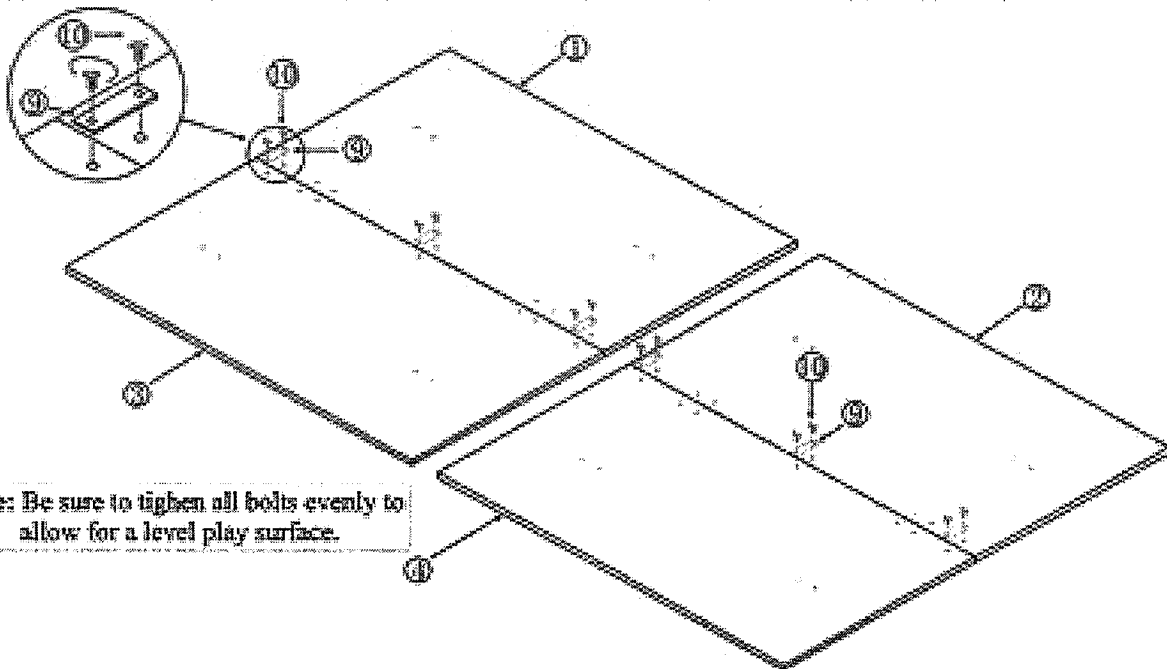

Note: Be sure to tighten all bolts evenly to allow for a level play surface.

Step 2- Attach the legs to the bottom of the table. Be sure to place large legs on the outside and the small legs on the inside. Using Both the Large and Small Leg Brackets # (19) and # (20) attach legs to the table. Use Bolts # (10) to attach brackets. See diagram for proper bracket placement. Next attach wheels # (26) to the inside set of legs by simply pushing them in.

STEP 2

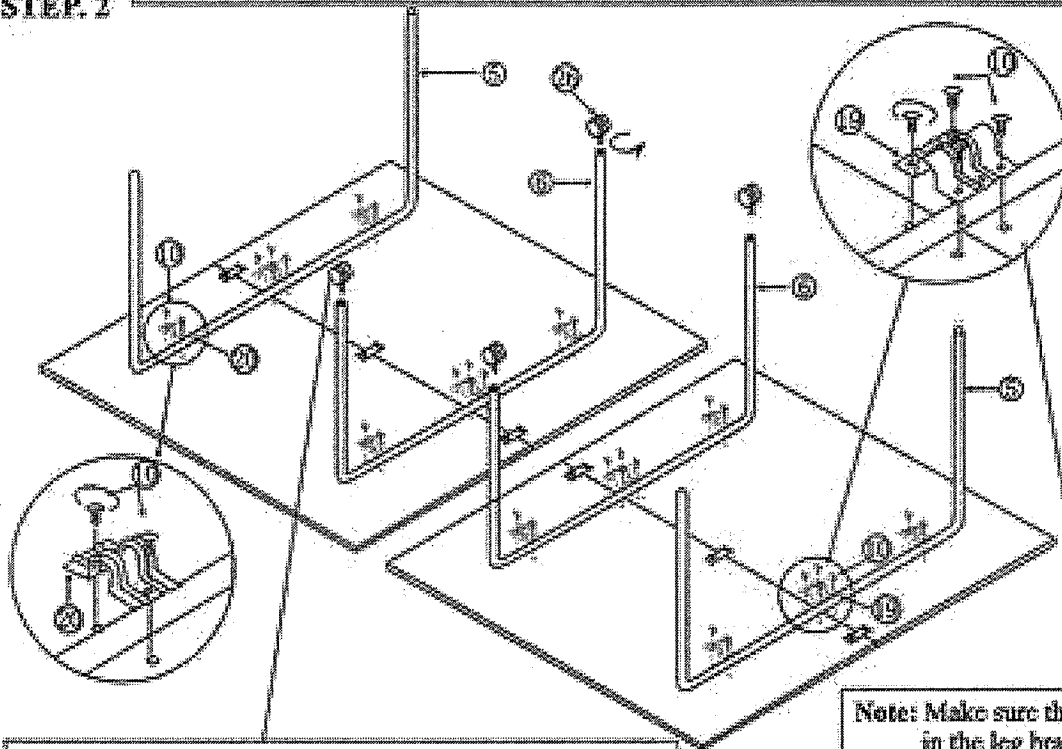

Note: Wheels #26 are adjustable. Please adjust each wheel to make the play surface level.

Note: Make sure that the oval cut out in the leg brackets are facing the table end for proper installation.

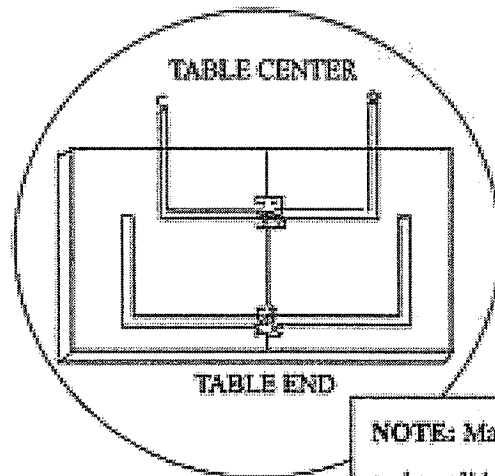

NOTE: Make sure to lay down the large and small legs face to the table center when attach the leg bracket.

STEP 3

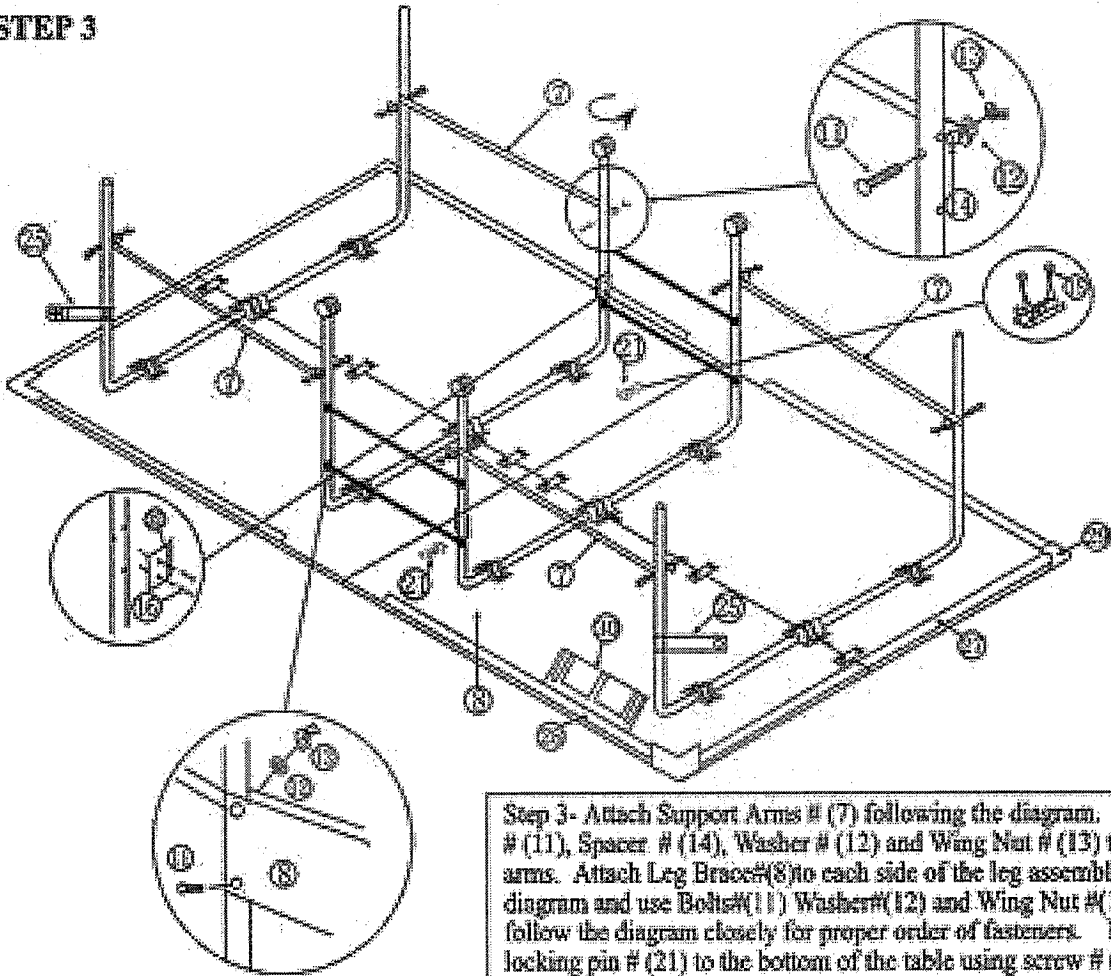

Step 3- Attach Support Arms # (7) following the diagram. Use Bolt # (11), Spacer # (14), Washer # (12) and Wing Nut # (13) to secure the arms. Attach Leg Braces#(8) to each side of the leg assembly follow to the diagram and use Bolts#(11) Washer#(12) and Wing Nut # (13). Be sure to follow the diagram closely for proper order of fasteners. Next attach locking pin # (21) to the bottom of the table using screw # (15). Following diagram slide safety straps #25 onto the outside legs. Next attach front metal apron # (27) and side metal apron # (28) to the table using screws # (18). Next attach protective corner pieces # (29) using screws # (17). Attach storage bag # (30) to the side metal apron using screws # (18). Follow diagram for proper placement.

STEP 4.

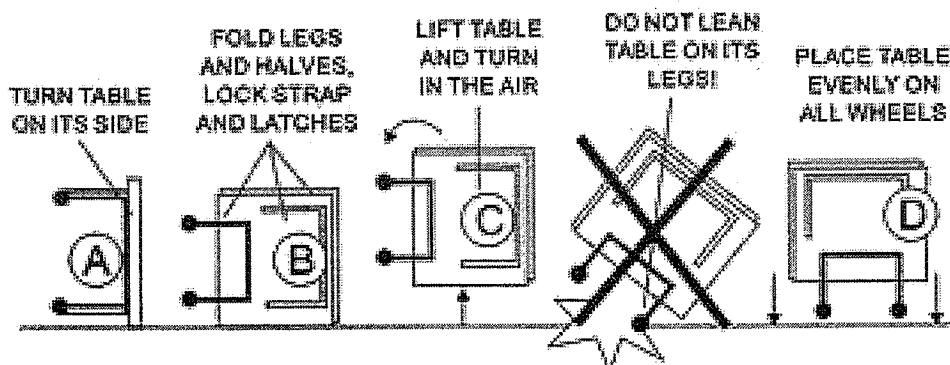

CAUTION: Three to four strong adults are recommended to flip the table as shown.

1. Turn the table on its side.
2. Fold in the two legs, fold the two table halves together, and lock the Safety Strap and Latches.
3. Lift the table off the floor and place it on all four wheels at the same time on the ground.
4. When turning table over to standing position be sure not to lean the table on its legs. This will cause the legs and or wheels to break.

STEP 5.

Step 5. Apply the line tape # (31) to the center of the table.

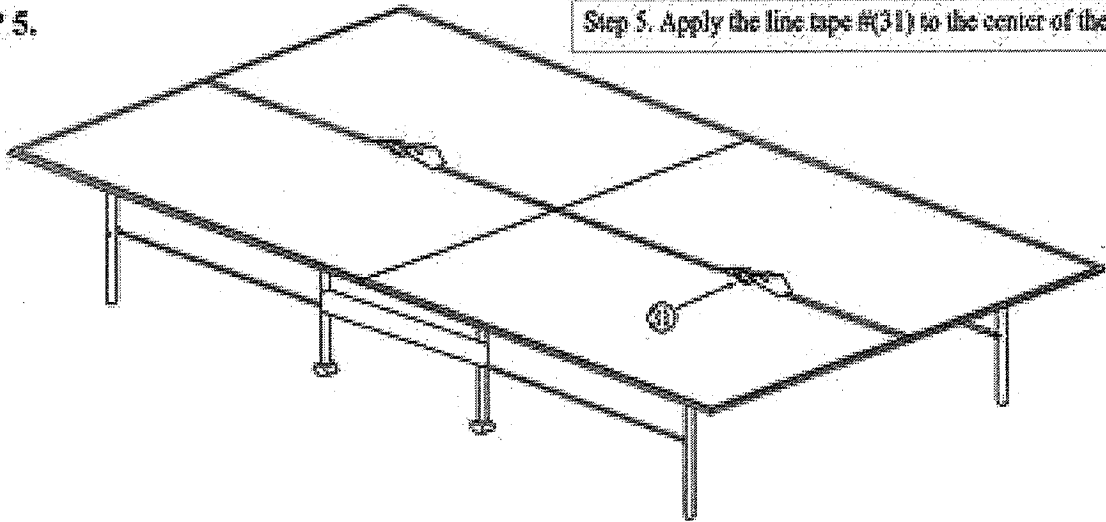

STEP 6. Attach the net support # (32) at each end of one table half. Slide the elastic band of the net over the post of the net support. Stretch the net # (33) to the other side and slip the elastic band over the post on the opposite side.

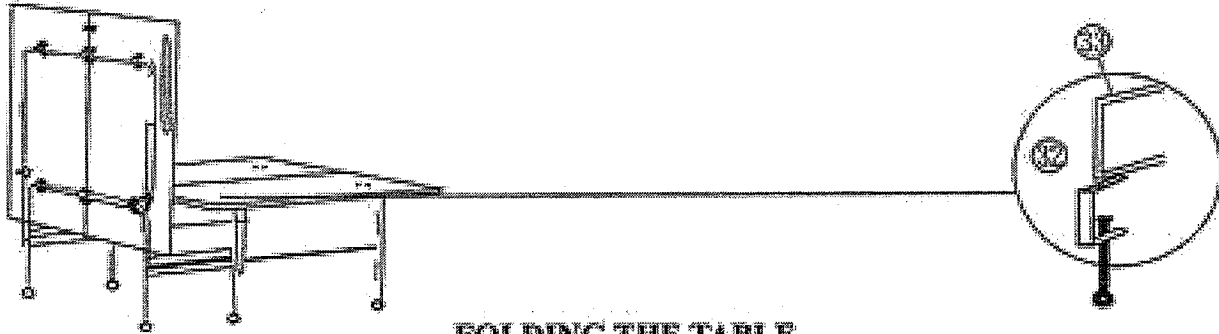

FOLDING THE TABLE

Step 1 - First fold the table half with out the net. Hold the end securely and lift until the linkage bar snaps into place. Repeat for other side.

Note: When table is folded up always attach safety strap to ensure that the table does not fall down to open position.

**For single play fold down half with out attached net.

**To unfold table pull on bottom of the large leg to release it from its locking device. Slowly lower table end down to floor.

Always use safety strap when table is folded.

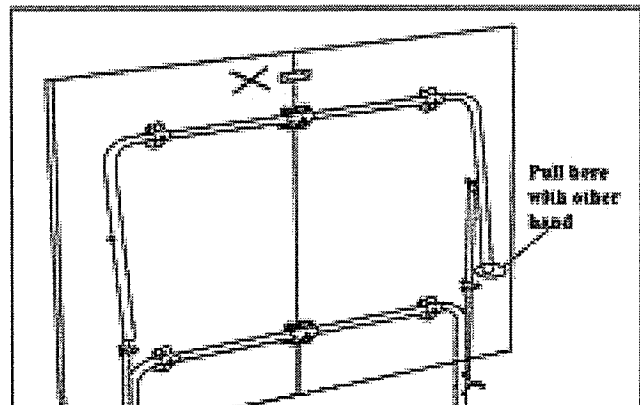
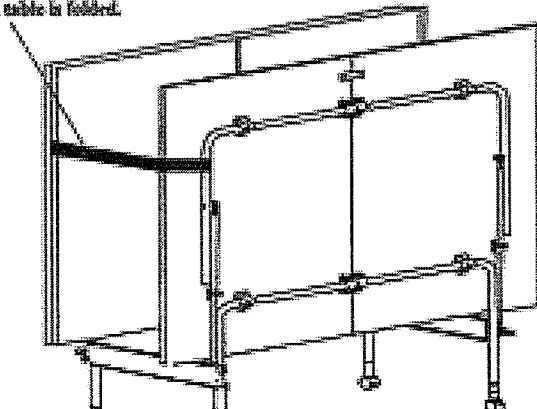

PARTS ORDER FORM

If for some reason you are missing any assembly parts for your Hallex game table, please call the Regent Sports Customer Service line at (877) 516-9707 (toll free) between the hours of 10:00am and 5:00 pm EST or go online at www.regent-hallex.com for parts ordering. Please refer to the REGENT SPORTS LIMITED WARRANTY concerning missing and defective parts.

Parts also may be ordered by filling out the form below. Please fill in all the information and return to:
REGENT SPORTS CORP.
 45 RANICK ROAD
 HAUPPAUGE, NEW YORK, 11788
 ATTN: CUSTOMER SERVICE

REGENT SPORTS CORP. requires that all orders for replacement parts must be paid by check, money order, VISA, or MC. Cash is not accepted. Please make all checks or money orders payable to REGENT SPORTS CORP. Please note all prices include shipping and handling.

Name of Purchaser: _____
 Address: _____
 City: _____
 State: _____ Zip Code: _____
 Phone: _____

Part #	Description	Quantity	Price	Total Cost
196-63545-01	TABLE SURFACE 1	1	\$10.00 EACH	
196-63545-02	TABLE SURFACE 2	1	\$10.00 EACH	
196-63545-03	TABLE SURFACE 3	1	\$10.00 EACH	
196-63545-04	TABLE SURFACE 4	1	\$10.00 EACH	
196-63545-05	LARGE U-LEG	2	\$10.00 EACH	
196-63545-06	SMALL U-LEG	2	\$10.00 EACH	
196-63545-07	SUPPORT ARM	4	\$5.00 EACH	
196-63545-08	LEG BRACE 7"	2	\$5.00 EACH	
196-63545-09	BRACKET	6	\$1.00 EACH	
196-63545-10	M6x10 BOLT	44	\$1.00 EACH	
196-63545-11	M6x50 BOLT	16	\$1.00 EACH	
196-63545-12	WASHER	16	\$1.00 EACH	
196-63545-13	WING NUT	16	\$1.00 EACH	
196-63545-14	SPACER	8	\$1.00 EACH	
196-63545-15	M3x10 SCREW	8	\$1.00 EACH	
196-63545-16	M4x13 SCREW	4	\$1.00 EACH	
196-63545-17	M4x25 SCREW	12	\$1.00 EACH	
196-63545-18	M4x12 SCREW	27	\$1.00 EACH	
196-63545-19	LARGE LEG BRACKET	4	\$5.00 EACH	
196-63545-20	SMALL LEG BRACKET	8	\$3.50 EACH	
196-63545-21	LOCK PIN	2	\$1.00 EACH	
196-63545-22	BRACKET	2	\$1.00 EACH	
196-63545-23	TABLE TENNIS PADDLES	2	\$1.00 EACH	
196-63545-24	TABLE TANNIS BALLS	3	\$1.00 EACH	
196-63545-25	SAFETY STRAPE SET 89cm	1	\$2.00 EACH	
196-63545-26	WHEEL	4	\$2.00 EACH	
196-63545-27	FRONT METAL APRON 1.3M	2	\$2.50 EACH	
196-63545-28	SIDE METAL APRON 1.25M	4	\$2.50 EACH	
196-63545-29	PROTECTIVE CORNER	4	\$5.00 EACH	
196-63545-30	STORAGE BAG	1	\$2.00 EACH	
196-63545-31	TAPE	1	\$1.00 EACH	
196-63545-32	NET SUPPORT	2	\$2.50 EACH	
196-63545-33	NET SET	1	\$5.00 EACH	