

TABLE

# Games

*Assembly instructions*



63430

**Halex**

TM

## CARE AND USE OF YOUR TABLE

**WARNING:** To reduce the risk of fire, electric shock or injury to persons, use this unit only in the manner intended by the manufacturer. If you have any question, contact the manufacturer. Before servicing or cleaning the unit, switch the power off and unplug the adapter from the wall outlet.

This appliance has a polarized plug (one blade is wider than the other). To reduce the risk of electric shock, this plug is intended to fit in a polarized outlet only one way. If the plug does not fit fully in the outlet, reverse the plug. If it still does not fit, contact a qualified electrician. **DO NOT** attempt to defeat this safety feature.

1. Use spray furniture polish to clean all exterior surfaces of your game table.
2. Use only a suitable 120v AC household outlet.
3. This product is intended for INDOOR use only.
4. DO NOT sit, climb or lean on the table.
5. DO NOT drag the table when moving it. This will damage the leg.
6. The fan should be unplugged before cleaning and servicing.

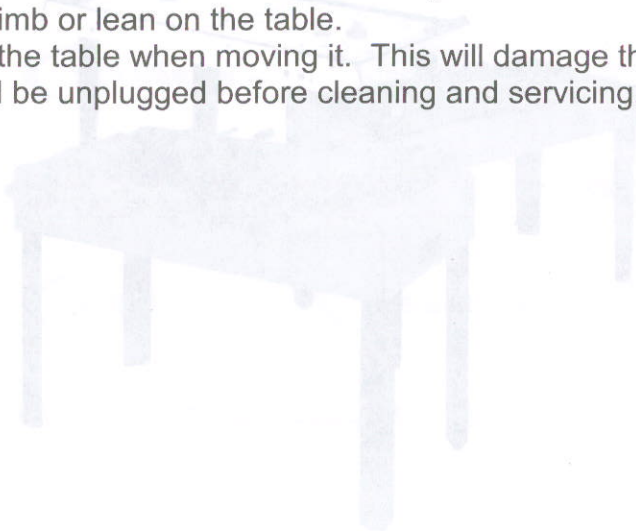

03430

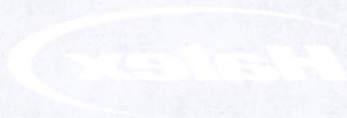

## **LIMITED 90 DAY WARRANTY**

This Halex product is warranted to be free from defects in workmanship or materials at the time of purchase for a period of 90 (ninety) days. Certain restrictions apply (see below).

Should any evidence of defects appear within the limited warranty period after the date of purchase, Regent Sports will either send replacement parts or advise of another course of action. A list of replaceable parts can be found on the parts order form page of this manual. Parts not listed on this order form are not replaceable. **Table tops, playing surfaces, and main frames are not replaceable.** This warranty covers normal consumer use and does not cover failures, which result from alterations, accidents, misuse, abuse, or neglect.

For prompt warranty service and special offers, please register your Halex product at our customer service center by visiting our website at: [www.regent-halex.com](http://www.regent-halex.com). Enter the following unique registration number followed by the item number of your table found on the cover of this manual: 1ZAK7 \_\_\_\_\_. You can also register your product on our automated voice recognition system at the toll free number below. You must register your product within 30 days of purchase to be eligible for warranty service. Please make sure to visit our website to order additional parts not covered under the warranty, as well as on-line instruction manuals and new product information. You may also order parts by calling our automated voice recognition system.

**A purchase receipt or other proof of date of purchase will be required before warranty service is performed.** Requests for warranty service can be provided by e-mailing the customer service department at [cstables@regent-halex.com](mailto:cstables@regent-halex.com) or by calling customer service at:

**877-516-9707 (Toll Free)**

**10:00 AM to 6:00 PM, EST. (Dec. through Jan.)**

**10:00 AM to 5:00 PM, EST. (Feb. through Nov.)**

Or send request in writing to:

**Regent Sports Corporation**



45 Ranick Road

Hauppauge, NY 11788

Attn: Halex Customer Service

This warranty gives you specific legal rights and you may have other rights that vary from state to state.

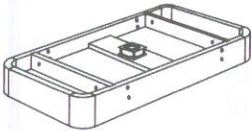
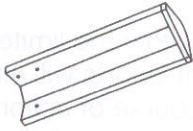
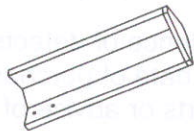
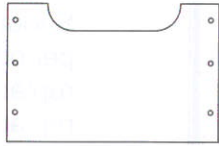
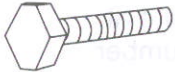
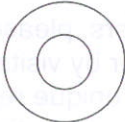
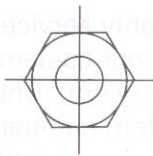
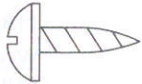
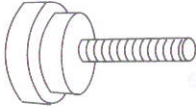
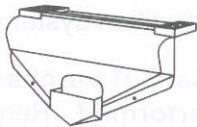
# PARTS LIST FOR POWER GLIDE HOCKEY

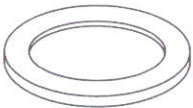
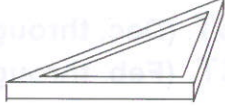
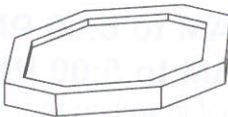
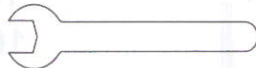
<p>#1</p>  <p>Main Frame 1 piece</p>	<p>#2</p>  <p>Left leg 2 pieces</p>	<p>#3</p>  <p>Right leg 2 pieces</p>	<p>#4</p>  <p>Leg end panel 2 pieces</p>
<p>#5</p>  <p>Leg bolt 12 pieces</p>	<p>#6</p>  <p>Leg washer 24 pieces</p>	<p>#7</p>  <p>Leg nut 12 Pieces</p>	<p>#8</p>  <p>1/2" screw 20 pieces</p>
<p>#9</p>  <p>Leg leveler 4 pieces</p>	<p>#10</p>  <p>Goal 2 pieces</p>	<p>#11</p>  <p>Pusher 2 pieces</p>	<p>#12</p>  <p>Pusher felt sticker 2 pieces</p>
<p>#13</p>  <p>Round puck 2 pieces</p>	<p>#14</p>  <p>Triangle puck 1 piece</p>	<p>#15</p>  <p>Octagon puck 1 piece</p>	<p>#16</p>  <p>Wrench 1 piece</p>

# Assembly Instructions for Power Glide Hockey

## Step 1

Place the main frame #1 face down on a clean, flat surface. Attach the legs #2 and #3 to the main frame using bolts #5, washers #6, and nuts #7 as shown. Attach the leg panels #4 to each set of legs using screws #8. Screw the leg levelers #9 into the bottom of each leg.

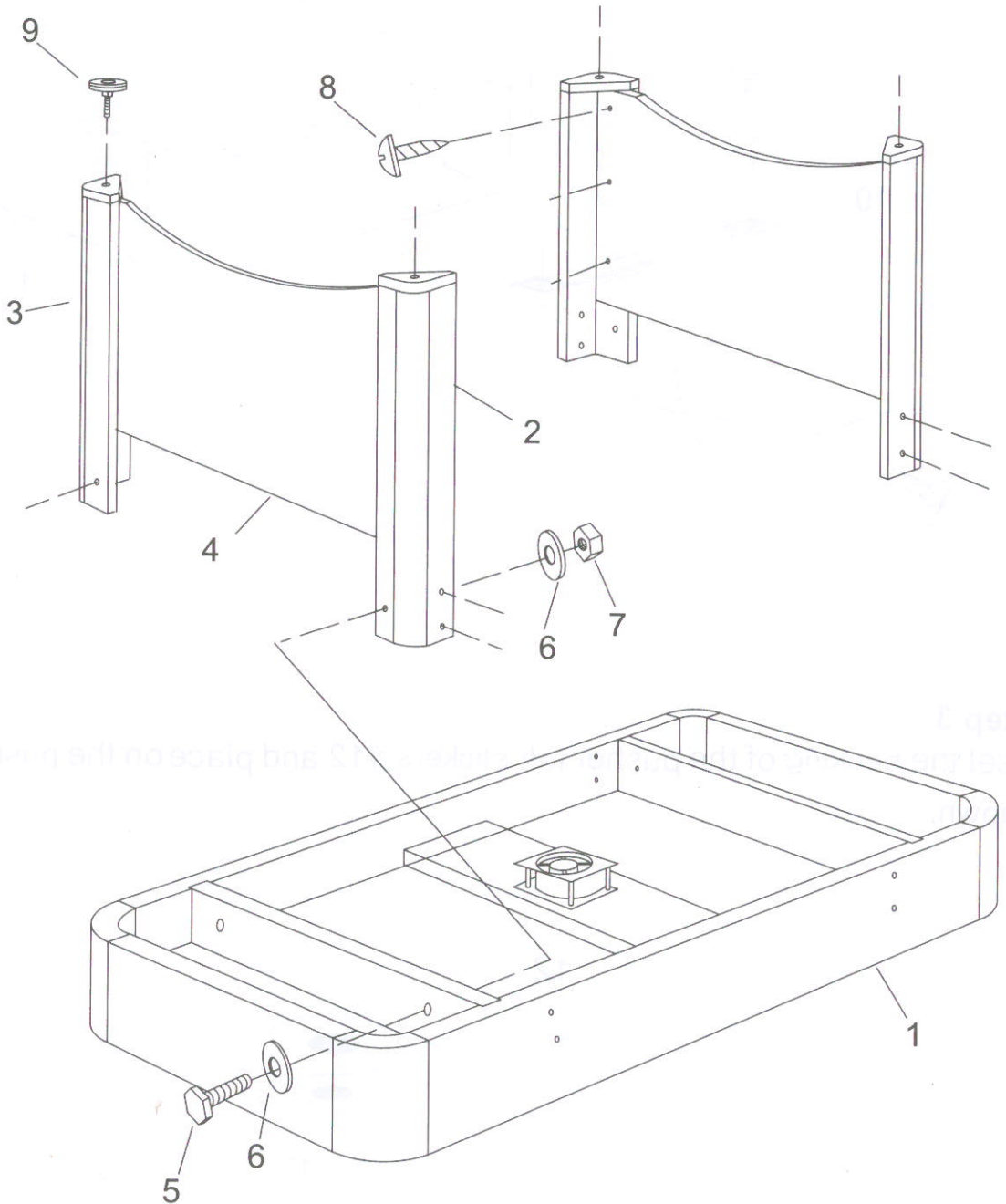

## Step 2

With the help of another adult, carefully flip the table over. Attach the goals #10 to each end of the table using the screws #8 as shown.

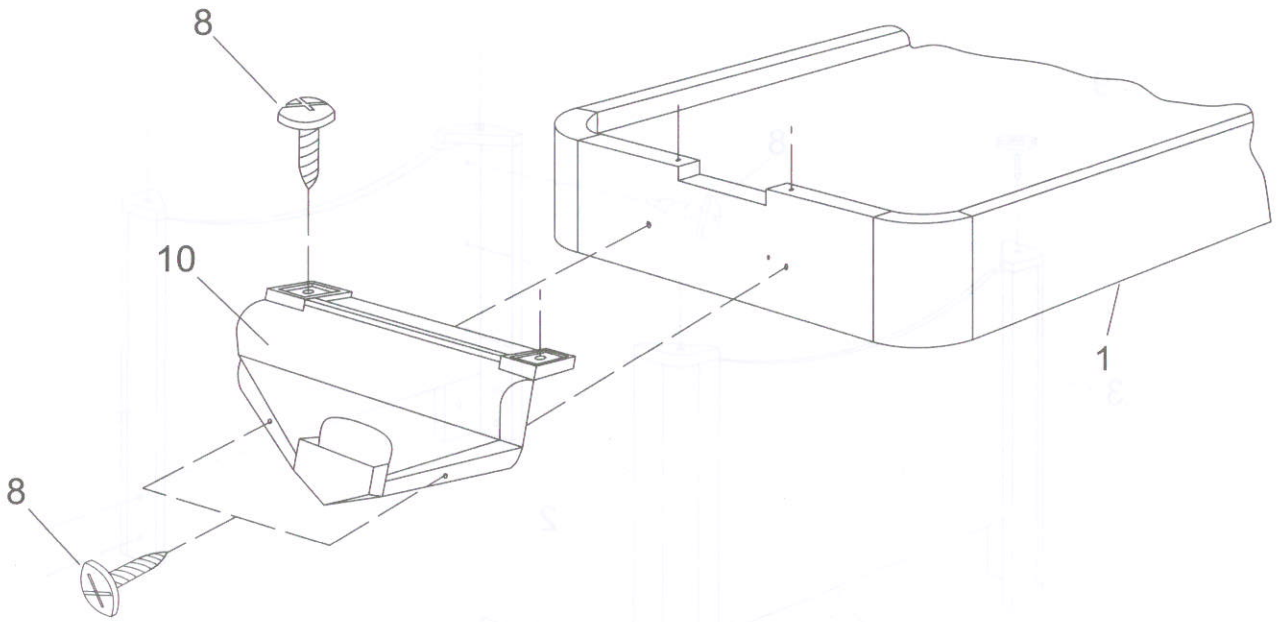

## Step 3

Peel the backing of the pusher felt stickers #12 and place on the pushers #11 as shown.

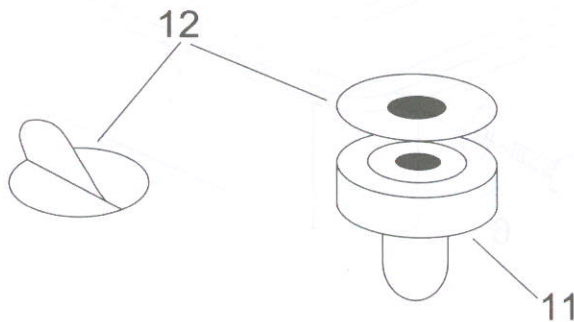

# **Power Glide Hockey**

## **Rules of Play**

### **The Object of the Game**

The object of Power Glide Hockey is to be the first player to score 10 goals against the opposing player.

### **Beginning the Game**

A coin toss is used to determine which player starts with the puck ("serve"). The player winning the coin toss gets the puck and begins play by striking the puck with his/her pusher onto the opponent's side.

### **During Play**

Players can strike the puck anywhere on their half of the playing surface. Players cannot cross the centerline to strike the puck. If a goal is scored when a player strikes the puck over the centerline, it does not count.

A player may stand anywhere around the table on his/her side of the centerline. Players may not stand past that line.

When the puck contacts any part of the centerline, either player may strike the puck to score.

### **Scoring**

A goal is scored when the puck enters and drops inside the opponent's goal.

The player scored upon receives possession of the puck for the next serve.

### **What Counts as a Goal?**

If the puck stops in the goal and has tilted into the goal drop, it counts as a goal.

If the puck stops in the goal and has not tilted into the goal, it does not count as a goal. Player can move the puck out of the goal area with his/her hand or pusher.

If the puck rebounds out of the goal, the point does not count.

### **Winning**

The first player to score 10 points is declared the winner.



## PARTS ORDER FORM

If for some reason you are missing any assembly parts for your Halex game table, please call the Regent Sports Customer Service line at (877) 516-9707 (toll free) between the hours of 10:00am and 5:00pm EST or go online at [www.regent-halex.com](http://www.regent-halex.com) for parts ordering. Please refer to the REGENT SPORTS LIMITED WARRANTY concerning missing and defective parts.

Parts also may be ordered by filling out the form below. Please fill in all the information and return to:

REGENT SPORTS CORP.  
45 RANICK ROAD  
HAUPPAUGE, NEW YORK, 11788  
ATTN: CUSTOMER SERVICE

REGENT SPORTS CORP. requires that all orders for replacement parts must be paid by check, money order, VISA, or MC. Cash is not accepted. Please make all checks or money orders payable to REGENT SPORTS CORP. *Please note all prices include shipping, handling, and all applicable taxes.*

**Name of Purchaser:** \_\_\_\_\_  
**Address:** \_\_\_\_\_  
**City:** \_\_\_\_\_  
**State:** \_\_\_\_\_ **Zip Code:** \_\_\_\_\_  
**Phone:** \_\_\_\_\_

PART #	DESCRIPTION	QUANTITY	PRICE	TOTAL COST
193-63430-2	Left Leg		\$17.50	
193-63430-3	Right Leg		\$17.50	
193-63430-4	Leg End Panel		\$10.00	
193-63430-5	Leg Bolt		\$1.00	
193-63430-6	Leg Washer		\$1.00	
193-63430-7	Leg Nut		\$1.00	
193-63430-8	1/2" Screw		\$1.00	
193-63430-9	Leg Leveler		\$5.00	
193-63430-10	Goal		\$7.50	
193-63430-11	Pusher		\$3.00	
193-63430-12	Pusher Felt Sticker		\$1.50	
193-63430-13	Round Puck		\$1.00	
193-63430-14	Triangle Puck		\$1.00	
193-63430-15	Octagon Puck		\$1.00	

Also be sure to check out our web site at:

[www.regent-halex.com](http://www.regent-halex.com)

- Parts Ordering
- Owners Manual
- Product Information

ATTN: CUSTOMER SERVICE

REGENT SPORTS CORP. requires that all orders for replacement parts must be paid by check or money order. VISA or MC Cash is not accepted. Please make all checks or money orders payable to REGENT SPORTS CORP. Please note all prices exclude shipping, handling, and all applicable taxes.

Name of Purchaser: \_\_\_\_\_  
Address: \_\_\_\_\_  
City: \_\_\_\_\_  
State: \_\_\_\_\_  
Zip Code: \_\_\_\_\_



© 2004

Regent Sports Corporation  
Hauppauge, New York