

Games

Assembly instructions

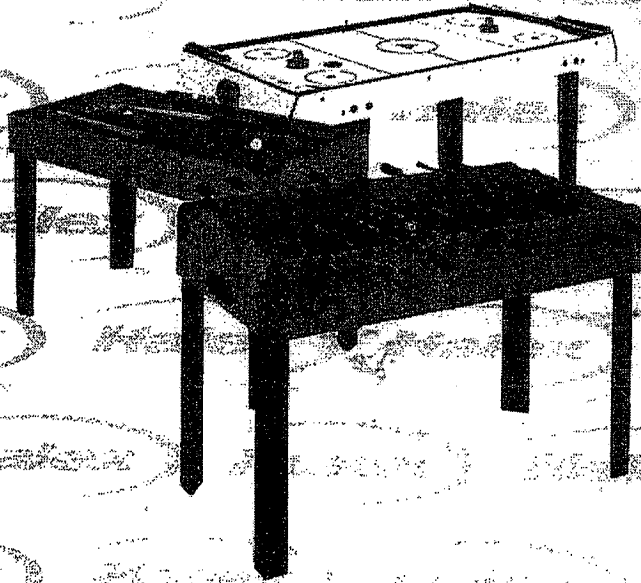

Halex

60015

Should you have a defect or parts issue, please refer to the warranty instructions listed below and contact Regent Sports at our toll free number!!

LIMITED 90 DAY WARRANTY

This Halex product is warranted to be free from defects in workmanship or materials at the time of purchase for a period of 90 (ninety) days. Certain restrictions apply (see below).

Should any evidence of defects appear within the limited warranty period after the date of purchase, Regent Sports will either send replacement parts or advise of another course of action. A list of replaceable parts can be found on the parts order form page of this manual. Parts not listed on this order form are not replaceable. **Table tops, playing surfaces, and main frames are not replaceable.** This warranty covers normal consumer use and does not cover failures, which result from alterations, accidents, misuse, abuse, or neglect.

For prompt warranty service and special offers, please register your Halex product at our customer service center by visiting our website at: www.regent-halex.com. Enter the following unique registration number followed by the item number of your table found on the cover of this manual: 1ZAK7 _____. You must register your product within 30 days of purchase to be eligible for warranty service. Please make sure to visit our website to order additional parts not covered under the warranty, as well as on-line instruction manuals and new product information. You may also order parts by calling our automated voice recognition system (877) 516-8707.

A purchase receipt or other proof of date of purchase will be required before warranty service is performed. Requests for warranty service can be provided by e-mailing the customer service department at cstables@regent-halex.com or by calling customer service at:

877-516-9707 (Toll Free)

10:00 AM to 6:00 PM, EST. (Dec. through Jan.)

10:00 AM to 5:00 PM, EST. (Feb. through Nov.)











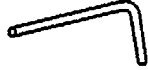

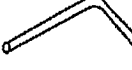

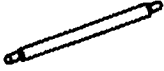
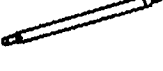



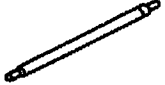

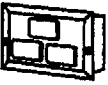













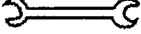

Or send request in writing to:

Regent Sports Corporation
45 Ranick Road
Hauppauge, NY 11788
Attn: Halex Customer Service

This warranty gives you specific legal rights and you may have other rights that vary from state to state.

60015 PARTS LIST & ASSEMBLY

PART I. PARTS LIST

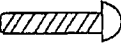
1  LONG L STYLE RING POLE 1-1/8" DIA 2PCS	2  RING POLE 1-1/8" DIA 2PCS	3  RING POLE 1-1/8" DIA 2PCS	4  RING POLE 19mm DIA 1PC	5  RING POLE 19mm DIA 1PC
6  RING POLE 5/8" DIA 2PCS	7  RING POLE 1-1/8" DIA 2PCS	8  RING POLE 1-1/8" DIA 2PCS	9  L STYLE RING POLE 1-1/8" DIA 2PCS	10  U- POLE 1-1/8" DIA 1PCS
11  RING POLE 12mm DIA 1PC	12  RAMP NET 1PC	13  ELECTRONIC SCORER 1PC	14  SENSOR PADDLE 2PCS	15  ADAPTER 1PC
16  BASKETBALL HOOP 2 PCS	17  STEEL SPACER PLATE 2PCS	18  4" PUMP W/ NEEDLE 1PC	19  RIM NET 2PCS	20  BACKBOARD 1PC
21  M6 WAhER 72 PCS	22  M6 x 3/4" BOLT 17PCS	23  M6 x 1-3/8" BOLT 6PCS	24  M6 x 1-5/8" BOLT 2PCS	25  M6 x 1-3/4" BOLT 4PCS
26  HEX NUT(M6) 34 PCS	27  STEEL INSERT PIN 2PCS	28  MINI-BASKETBALL 7" 2PCS	29  M6 x 2" BOLT 4PCS	30  M6 x 3/4" BOLT 4PCS
31  HEX NUT (M6) 4PCS	32  SPANNER 1PC	33  ALLEN KEY TOOL 1PC	34  2 1/2" BASEBALL 2PCS	35  6" SOCCER BALL 2PCS
36  (4-1/2" x 8") FOOTBALL 2PCS	37  3" x 1" HOCKEY PUCK 2PCS	38  HOCKEY/SOCCER NET 1PC	39  HOCKEY STICK 2PC	40  M6 x 1-1/4" BOLT 1 PC

PART 2. ASSEMBLY

Step1: Set up backboard, sensor stick and electronic scorer.

Attach Hoops #16 and Spacer Plate #17 to the Backboard. Use Screws # 22, Washers # 21 and Nuts # 26 to attach these parts. Spacer Plate Mounts to the Back of the Backboard. Next attach the Sensor Stick #14 using Screws #22 and Washers #21 and Nuts # 26. Finally attach Electronic Scorer using Screws # 30, Washers #21 and Nuts #31 to complete backboard set up.

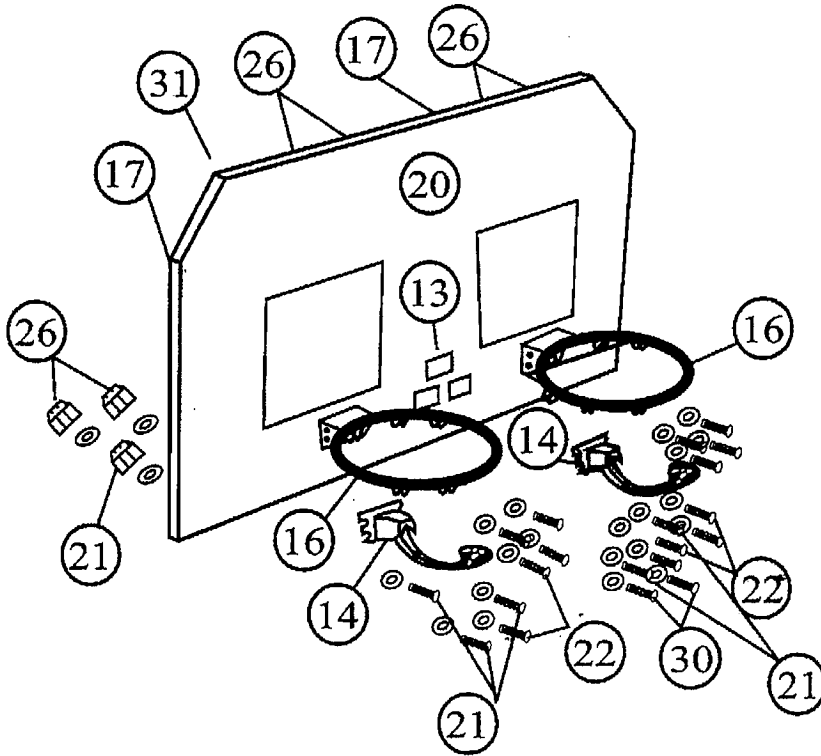

Step2: Set up for the metal frame.

With the help of another adult attach sections #1, #2 and #3. Next assemble leg sections #7 and #8 and attach them to section #2 using Bolts # 23 and Nuts #26. Next assemble U-Sections #5 and attach them to sections #3 and #8 using bolts #29, washers #21 and nuts #26. Next attach section #6 to sections #2 and #5 using bolts #23 and nut #26. Next attach sections #9 using bolts # 29 and nut #26. Next attach section #10 to section #9.

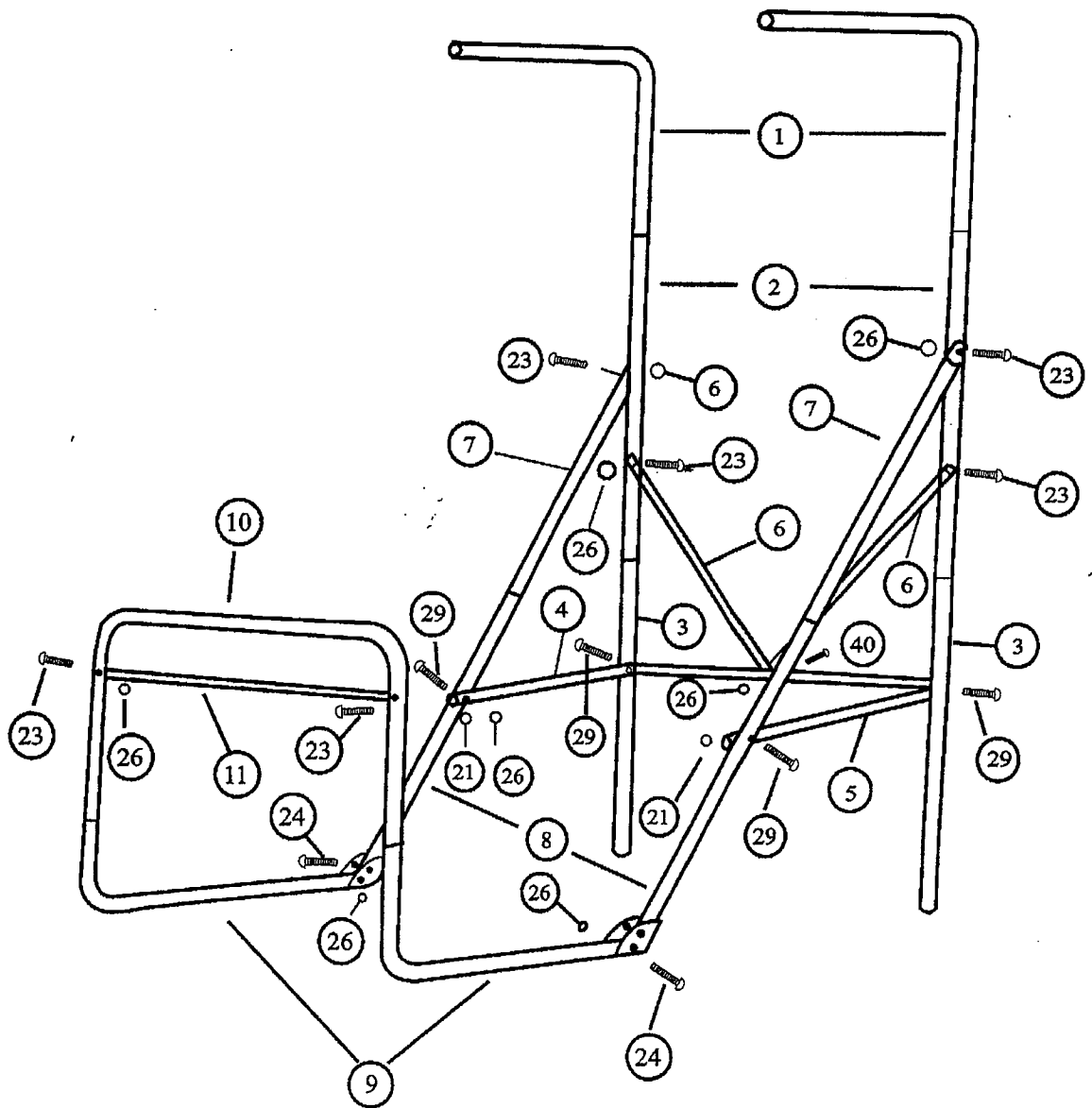

Step3:

Attach Backboard to Frame

Attach Backboard assembly to frame Assembly using bolts #25 washers #21 and nut # 26. The assistance of another person is suggested for the mounting of the backboard.

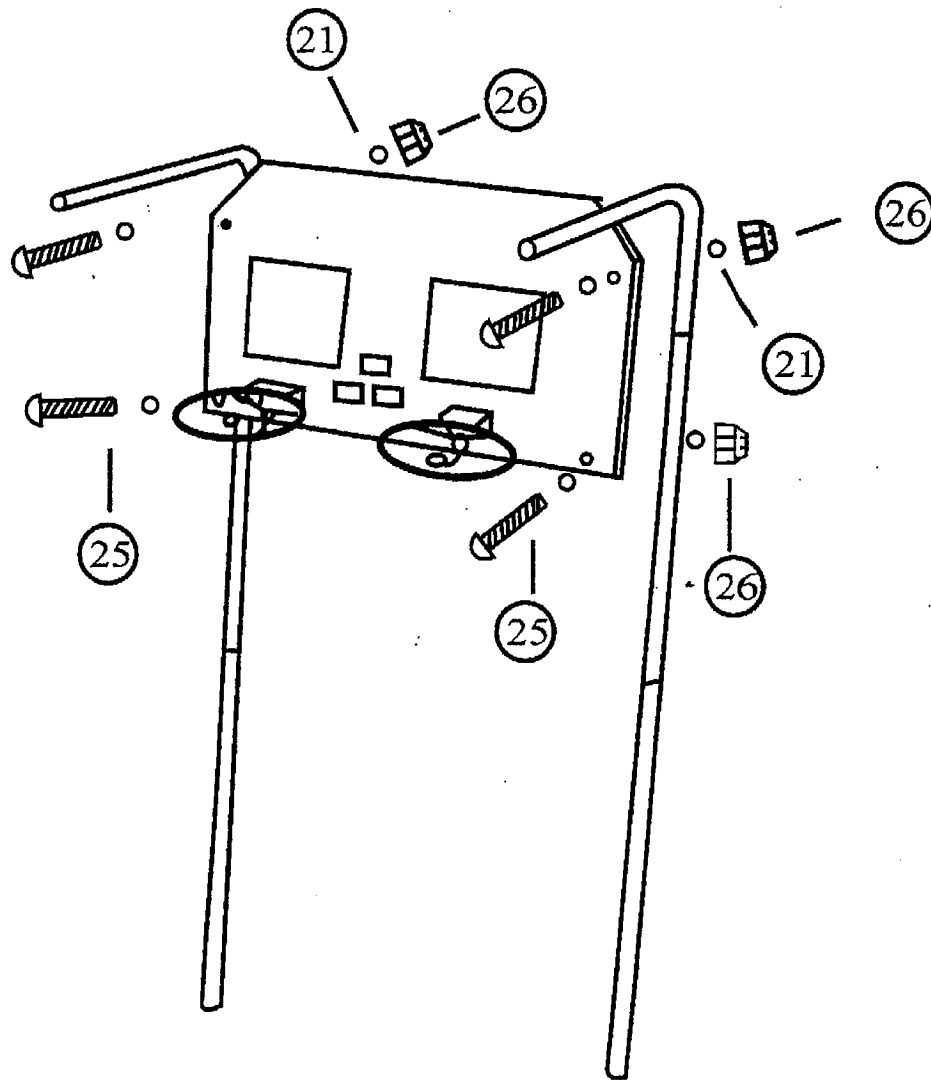

Step 4:

Slide ball ramp #12 onto frame. Follow diagram for proper placement.

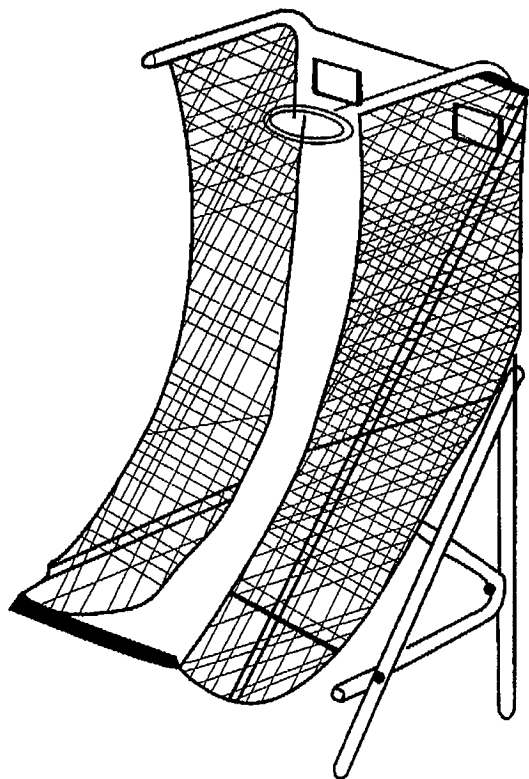
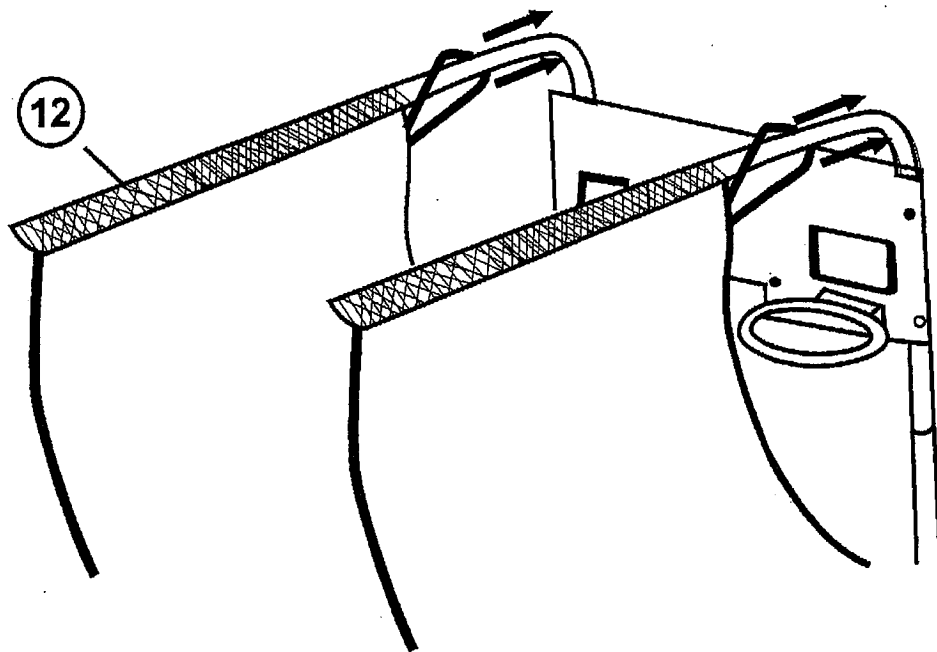

Step 5:

Slide Sleeve and End Loop of ball ramp over sections #9 and #10. In order to do this you must disconnect sections #9 and #10. Next slide Soccer Net #38 over sections #9 and reconnect all sections once completed. Secure Velcro end loop of ball ramp to section #10.

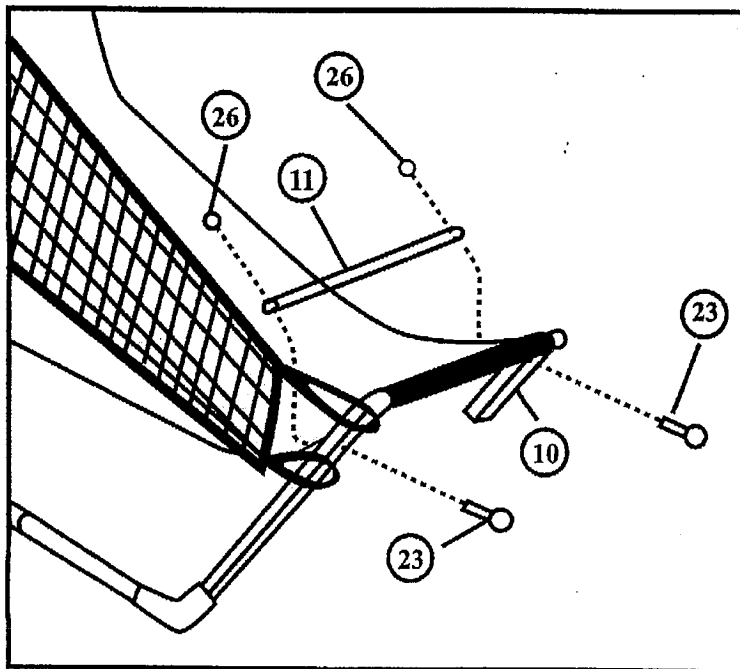
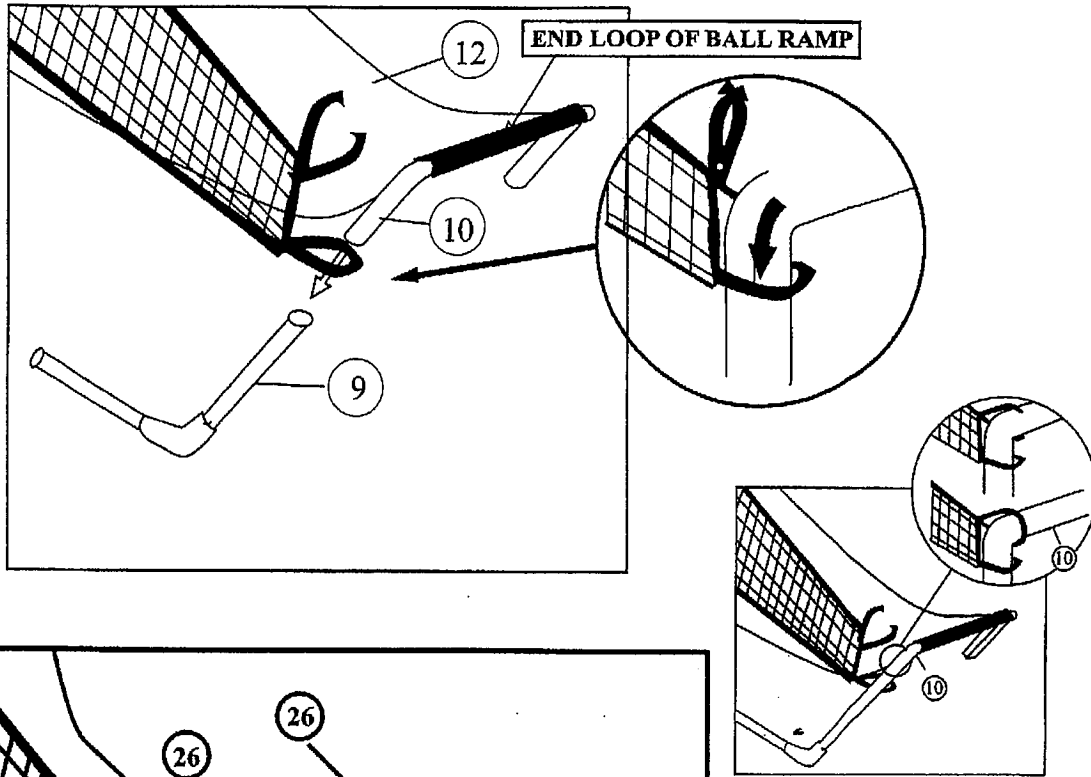

Step 6:

Attach frame cross brace #11 to ramp support tube# 10 with bolts #23 and nut #26 to add tension to ball ramp.

Warning:

For your safety, part# 27, the steel insert pin (lock pin) must be inserted when the game is folded in the upright position.

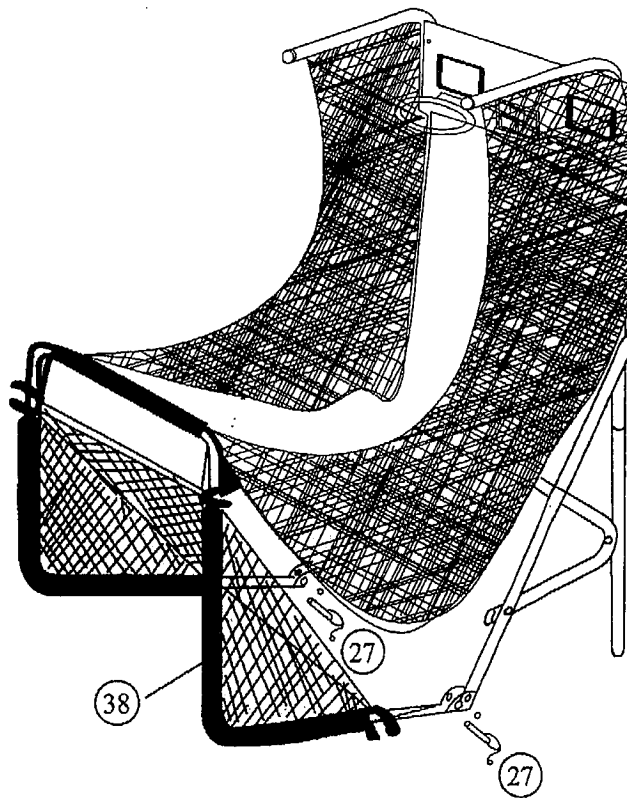

PARTS ORDER FORM

If for some reason you are missing any assembly parts for your Halex game table, please call the Regent Sports Customer Service line at (1877) 516-9707 (toll free) between the hours of 10:00am and 5:00 pm EST or go online at www.regent-halex.com for parts ordering. Please refer to the REGENT SPORTS LIMITED WARRANTY concerning missing and defective parts.

Parts also may be ordered by filling out the form below. Please fill in all the information and return to:

REGENT SPORTS CORP.
45 RANICK ROAD
HAUPPAUGE, NEW YORK, 11788
ATTN: CUSTOMER SERVICE

REGENT SPORTS CORP. requires that all orders for replacement parts must be paid by check, money order, VISA, or MC. Cash is not accepted. Please make all checks or money orders payable to REGENT SPORTS CORP. Please note all prices include shipping and handling.

Name of Purchaser: _____

Address: _____

City: _____

State: _____ **Zip Code:** _____

Phone: _____

Part #	Description	Quantity	Price	Total Cost
196-60015-01	Long L Style Ring Pole	2	\$12.00 each	
196-60015-02	Ring Pole Number 2	2	\$12.00 each	
196-60015-03	Ring Pole Number 3	2	\$12.00 each	
196-60015-04	Ring Pole Number 4	1	\$12.00 each	
196-60015-05	Ring Pole Number 5	1	\$12.00 each	
196-60015-06	Ring Pole Number 6	2	\$12.00 each	
196-60015-07	Ring Pole Number 7	2	\$12.00 each	
196-60015-08	Ring Pole Number 8	2	\$12.00 each	
196-60015-09	L Style Ring Pole Number 9	2	\$12.00 each	
196-60015-10	U-Pole Number 10	1	\$12.00 each	
196-60015-11	Ring Pole	1	\$12.00 each	
196-60015-12	Ramp Net	1	\$15.00 each	
196-60015-13	Electronic Scorer	1	\$15.00 each	
196-60015-14	Sensor Paddle	2	\$7.50 each	
196-60015-15	Adapter	1	\$7.50 each	
196-60015-16	Basketball Hoop	2	\$10.00 each	
196-60015-17	Steel Spacer Plate	2	\$5.00 each	
196-60015-18	Pump w/ Needle	1	\$3.50 each	
196-60015-19	Rim Net	2	\$5.00 each	
196-60015-20	Backboard	1	\$20.00 each	
196-60015-21	Washer	38	\$1.00 each	
196-60015-22	M6 x 3/4" Bolt	17	\$1.00 each	
196-60015-23	M6 x 1-3/8" Bolt	6	\$1.00 each	
196-60015-24	M6 x 1-5/8" Bolt	2	\$1.00 each	
196-60015-25	M6 x 1-3/4" Bolt	4	\$1.00 each	
196-60015-26	Hex Nut(M6)	34	\$1.00 each	
196-60015-27	Steel Insert Pin	2	\$2.00 each	
196-60015-28	Mini-Basketball	2	\$4.00 each	
196-60015-29	M6 x 2"Bolt	2	\$1.00 each	
196-60015-30	M5 x 3/4"Bolt	4	\$1.00 each	
196-60015-31	Hex Nut(M5)	4	\$1.00 each	
196-60015-32	Spanner	1	\$1.00 each	
196-60015-33	Allen Key Tool	1	\$1.00 each	
196-60015-34	Baseball	2	\$1.00 each	
196-60015-35	Soccer Ball	2	\$4.00 each	
196-60015-36	Football	2	\$4.00 each	
196-60015-37	Hockey Puck	2	\$3.00 each	
196-60015-38	Hockey/ Soccer Net	1	\$7.00 each	
196-60015-39	Hockey Stick	2	\$5.00 each	
196-60015-40	M6 x 1-5/8" Bolt	1	\$1.00 each	

Also be sure to check out our web site at:

www.regent-halex.com

• Parts Ordering • Owners Manual • Product Information



© 2006
Regent Sports Corporation
Hauppauge, New York