

Halex Halex Halex Ha

lex Halex Halex Halex

TABLE
Games

Assembly instructions

lex Halex Halex Halex

Halex Halex Halex Ha

lex Halex Halex Halex

Halex Halex Halex Ha

lex Halex Halex Halex

Halex Halex Halex Ha

lex Halex Halex Halex

Halex Halex Halex Ha



59555



LIMITED 90 DAY WARRANTY

This Halex product is warranted to be free from defects in workmanship or materials at the time of purchase for a period of 90 (ninety) days. Certain restrictions apply (see below).

Should any evidence of defects appear within the limited warranty period after the date of purchase, Regent Sports will either send replacement parts or advise of another course of action. A list of replaceable parts can be found on the parts order form page of this manual. Parts not listed on this order form are not replaceable. **Table tops, playing surfaces, and main frames are not replaceable.** This warranty covers normal consumer use and does not cover failures, which result from alterations, accidents, misuse, abuse, or neglect.

For prompt warranty service and special offers, please register your Halex product at our customer service center by visiting our website at: www.regent-halex.com. Enter the following unique registration number followed by the item number of your table found on the cover of this manual: 1ZAK7 _____. You must register your product within 30 days of purchase to be eligible for warranty service. Please make sure to visit our website to order additional parts not covered under the warranty, as well as on-line instruction manuals and new product information. You may also order parts by calling our automated voice recognition system at: 877-516-9707 (Toll Free).

A purchase receipt or other proof of date of purchase will be required before warranty service is performed. Requests for warranty service can be provided by e-mailing the customer service department at cstables@regent-halex.com or by calling customer service at:

877-516-9707 (Toll Free)

10:00 AM to 6:00 PM, EST. (Dec. through Jan.)

10:00 AM to 5:00 PM, EST. (Feb. through Nov.)

Or send request in writing to:

Regent Sports Corporation

















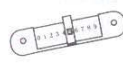

45 Ranick Road

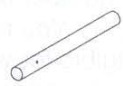
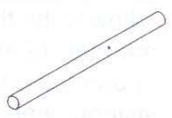
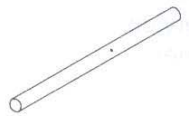
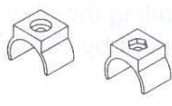
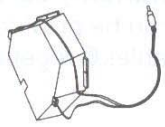



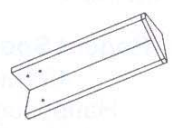
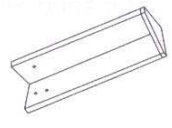
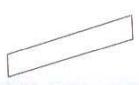









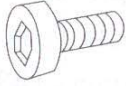



Hauppauge, NY 11788

Attn: Halex Customer Service

This warranty gives you specific legal rights and you may have other rights that vary from state to state.

59555 ROD HOCKEY PARTS LIST

<p>300-1007</p>  <p>Rod Hockey Puck 4Pieces</p>	<p>#2</p>  <p>Hockey Goal 2Pieces</p>	<p>#3</p>  <p>Short Stick Red Hockey Player 1Piece</p>	<p>#4</p>  <p>Long Stick Red Hockey Player 4Pieces</p>
<p>#5</p>  <p>Red Goalie 1Piece</p>	<p>#6</p>  <p>Short Stick Blue Hockey Player 1Piece</p>	<p>#7</p>  <p>Long Stick Blue Hockey Player 4Pieces</p>	<p>#8</p>  <p>Blue Goalie 1Piece</p>
<p>#9</p>  <p>Manual scorer 2Pieces</p>	<p>#10</p>  <p>Rod Handle 10Pieces</p>	<p>#11</p>  <p>Short Hockey Rod 4Pieces</p>	<p>#12</p>  <p>Medium Hockey Rod 2Pieces</p>
<p>#13</p>  <p>Long Hockey Rod 4Pieces</p>	<p>#14</p>  <p>Rod Stopper 20Pieces</p>	<p>#15</p>  <p>Puck Catcher 2Pieces</p>	<p>#16</p>  <p>Hockey Gear 10Pieces</p>
<p>#17</p>  <p>Triangle Block 4Pieces</p>	<p>#18</p>  <p>Playfield Block 2Pieces</p>	<p>#19</p>  <p>Left Leg 2Pieces</p>	<p>#20</p>  <p>Right Leg 2Pieces</p>
<p>#21</p>  <p>Side Leg Panel 2Pieces</p>	<p>#22</p>  <p>End Leg Panel 2Pieces</p>	<p>#23</p>  <p>Wrench 1Piece</p>	<p>#24</p>  <p>Tool 1Piece</p>

<p>#25</p>  <p>1/8"Round head screw 10Pieces</p>	<p>#26</p>  <p>5/4"Handle Bolt 10Pieces</p>	<p>#27</p>  <p>15/16"Rod Stopper Bolt 10Pieces</p>	<p>#28</p>  <p>Rod Stopper Nut 20Pieces</p>
<p>#29</p>  <p>5/16"Leg Bolt 12Pieces</p>	<p>#30</p>  <p>5/16"Leg Washer 24Pieces</p>	<p>#31</p>  <p>5/16"Leg nut 12Pieces</p>	<p>#32</p>  <p>5/8"Black Phillips Head Screw 4Pieces</p>
<p>#33</p>  <p>Goalie Iron Bar 2Pieces</p>	<p>#34</p>  <p>1/4"Round Head Screw 20Pieces</p>	<p>#35</p>  <p>Flat Washer 2Pieces</p>	<p>#36</p>  <p>Goalie Rod Bolt 2Pieces</p>
<p>#37</p>  <p>Goalie Rod Nut 2Pieces</p>	<p>#38</p>  <p>7/8"Phillips Screw 4Pieces</p>	<p>#39</p>  <p>1/2"Round Head Screw 20Pieces</p>	<p>#40</p>  <p>NHL Sticker sheet 1Piece</p>
<p>#41</p>  <p>5/8"White Phillips Head Screw 12Pieces</p>	<p>#42</p>  <p>Electronic Soccer 1Piece</p>		

Step 1

Affix the rod handles (#10) to the hockey rods (#11, #12, & #13) using the handle bolt (#26) and rod stopper nut (#28) as shown in the diagram. Slide the rods through the holes in the end panels. The long hockey rods (#13) should go through the outside holes of the end panel. The short rod (#11) should go through the middle hole in the end panel. The medium rods (#12) should go through the remaining holes on either side of the middle hole. Attach the rod stoppers (#14) to the hockey rods by screwing the rod stopper bolt (#27) and rod stopper nut (#28) through the hole in the middle of the rod as shown. Slide the end of the hockey rods into the rod acceptors and attach with the 1/4" round head screws (#34) as depicted in the diagram. Secure the puck catchers (#15) to the end panels using the 1/2" round head screws (#39).

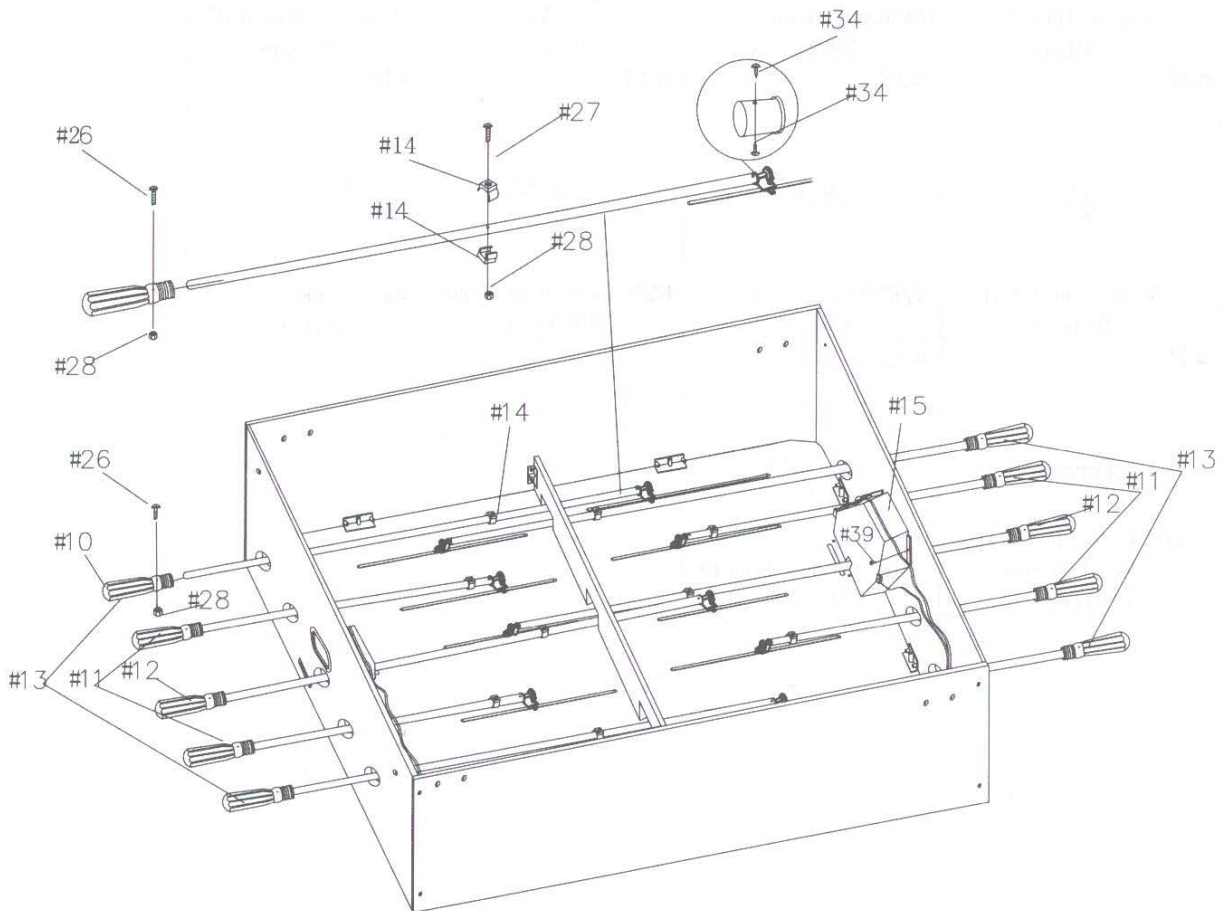

Step 2

Affix the right legs and left legs (#19) to the cabinet using the leg bolts (#29) leg washers (#30) and leg nuts (#31). Secure the side leg panels (#21) to the legs with the 1/2" round head screws (#39). Secure the end leg panels (#22) to the legs using the 1/2" round head screws (#39).

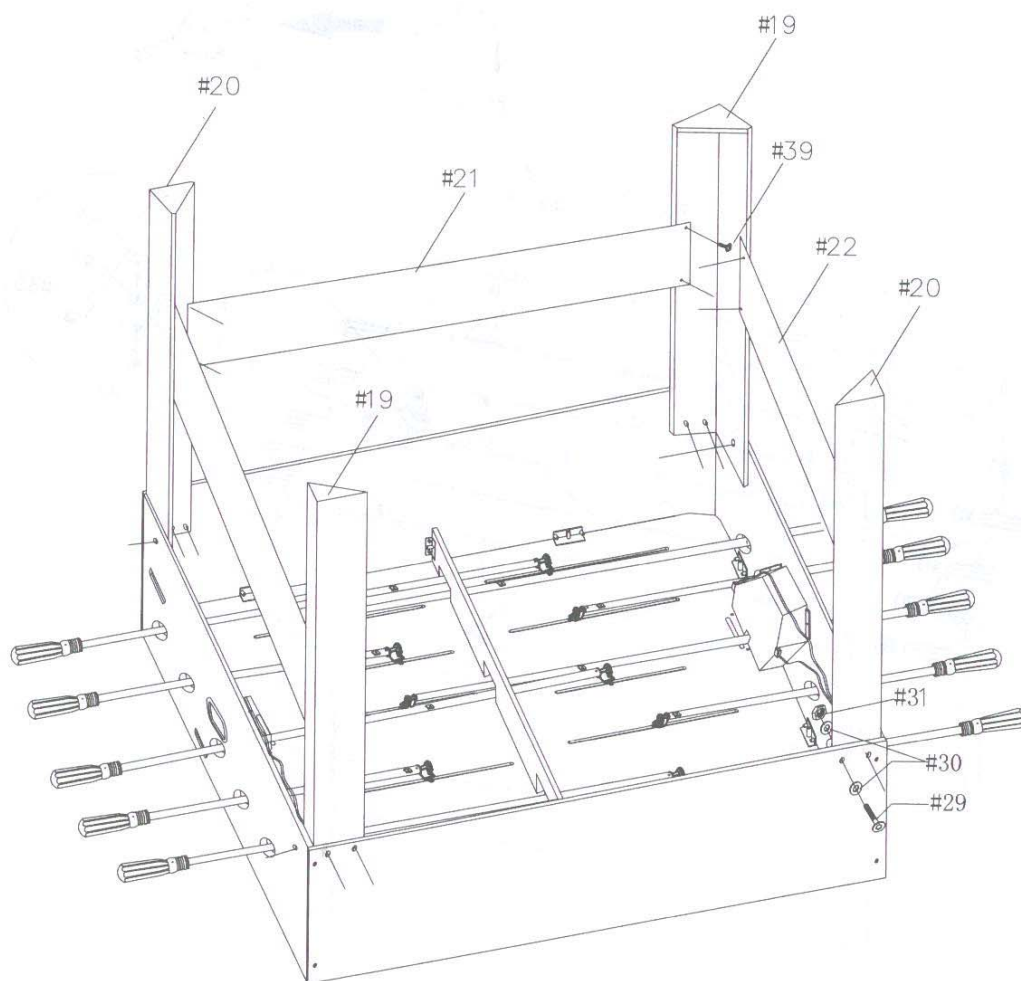

Step 3

With the help of another adult, carefully flip the table over. Secure the manual scorers (#9) onto the walls of the cabinet with the black Phillips head screws (#32). Place the goalie iron bar (#33) through the end panel so that the end with the hole is sticking through the goalie track on the playing surface. Secure the goalie iron bar with the goalie rod bolt (#36), flat washer (#35), and goalie rod nut (#37). Place the hockey players (#3, #4, #5, #6, #7, & #8) onto the screw acceptors of the hockey gears. Follow the diagram closely to make sure you put the right player on the appropriate rod. Secure the players with the 1/8" round head screws (#25).

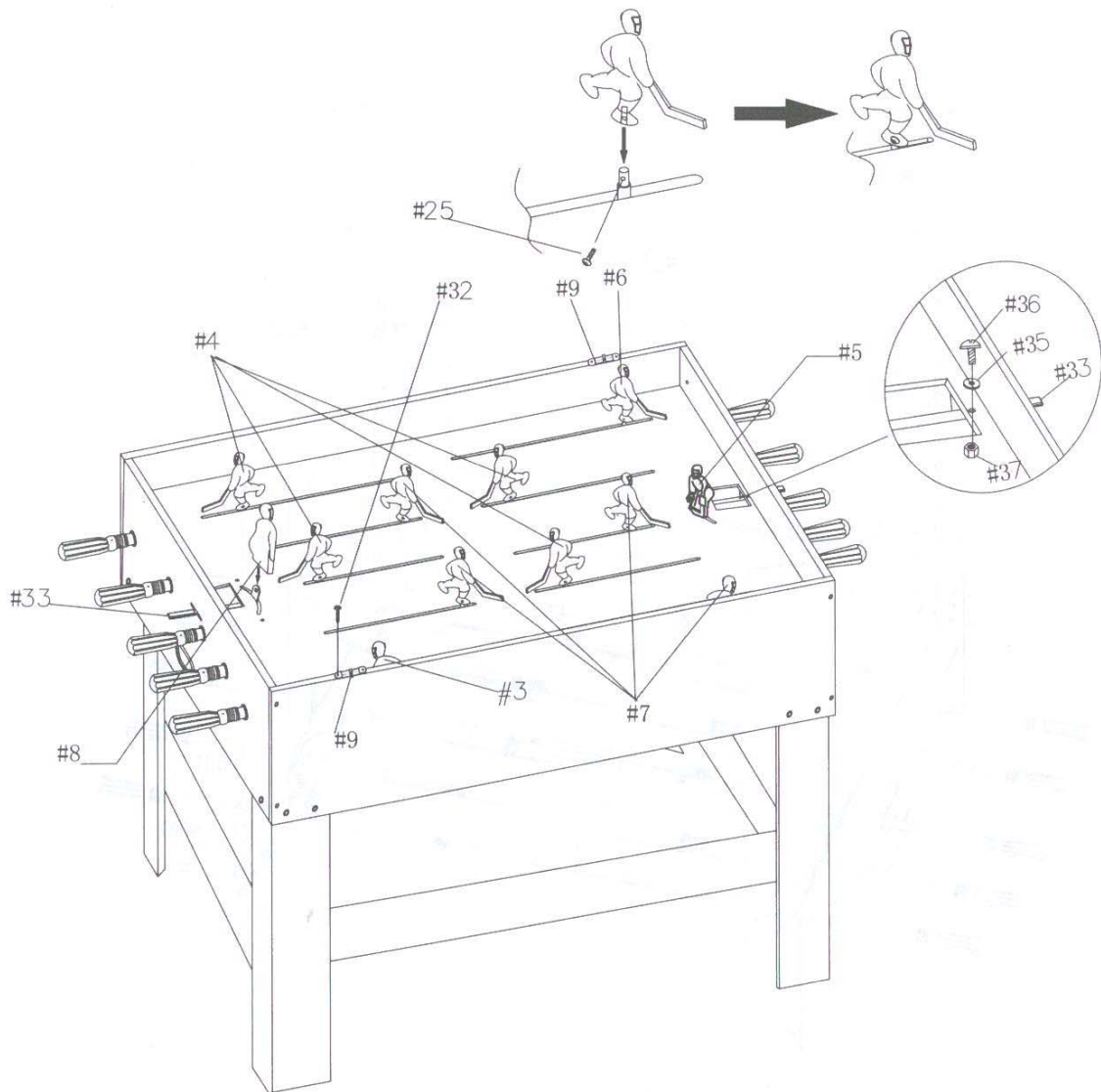

Step 4

Secure the electronic scorer (#42) to the side panel using the 7/8" Phillips head screws (#38). Connect the wires to the scoreboard as shown in the diagram. Place the goals (#2) into place behind the goalies. Place the Playfield blocks (#18) onto each end of the playing surface and secure with the 7/8" Phillips head screws (#38). Place the triangle block (#17) into each corner of the playing surface and secure with the 7/8" Phillips head screws.

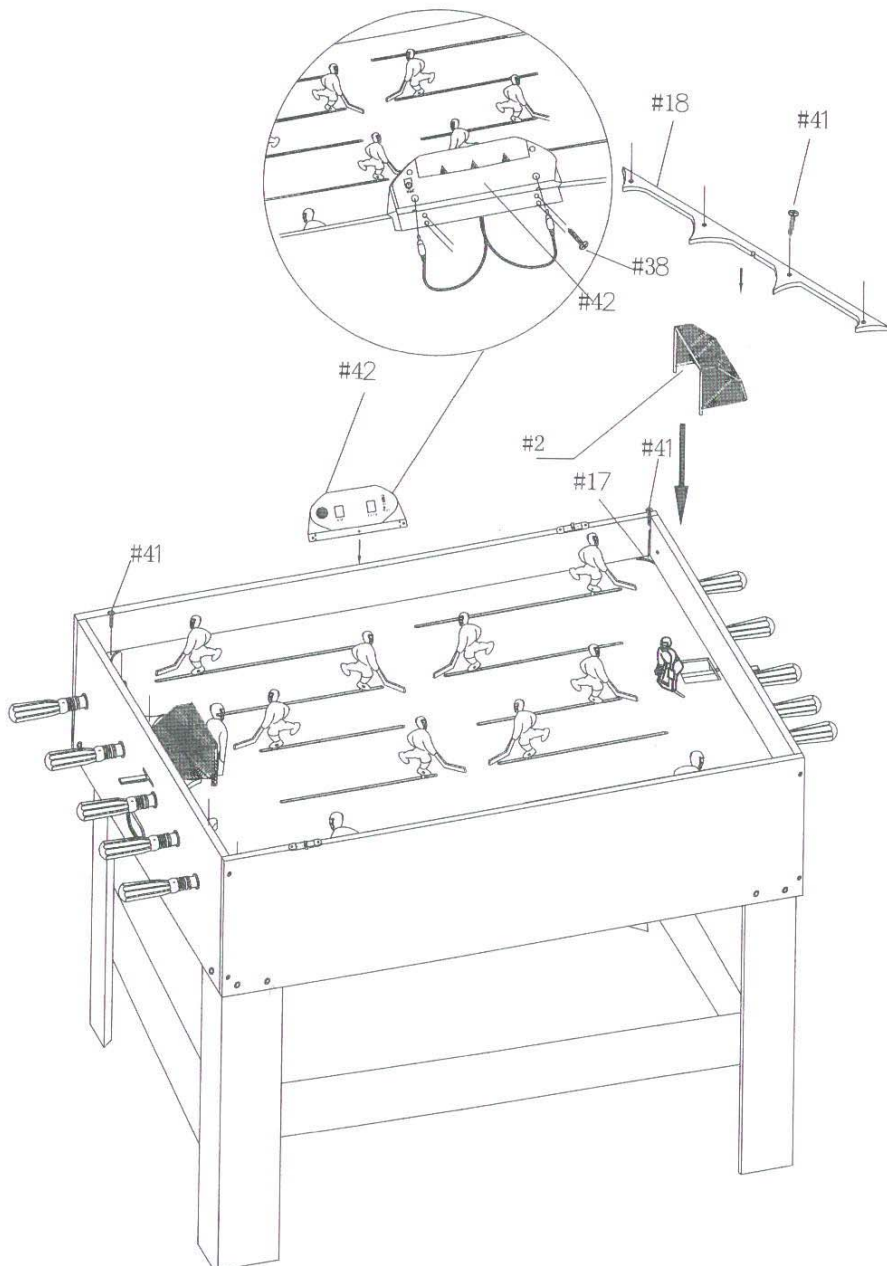

59555

PARTS ORDER FORM

Part #	Description	Quantity	Price	Total Cost
030-01007	Rod hockey puck	4	\$3.00	
194-59555-2	Hockey goal	2	\$5.00	
194-59555-3	Short stick red hockey player	1	\$5.00	
194-59555-4	Long stick red hockey player	4	\$5.00	
194-59555-5	Red goalie	1	\$5.00	
194-59555-6	Short stick blue hockey player	1	\$5.00	
194-59555-7	Long stick blue hockey player	4	\$5.00	
194-59555-8	Blue goalie	1	\$5.00	
194-59555-9	Manual scorer	2	\$5.00	
194-59555-10	Rod handle	10	\$3.00	
194-59555-11	Short hockey rod	4	\$5.00	
194-59555-12	Medium hockey rod	2	\$5.00	
194-59555-13	Long hockey rod	4	\$5.00	
194-59555-14	Rod stopper	20	\$2.00	
194-59555-15	Puck catcher	2	\$5.00	
194-59555-16	Hockey gear	10	\$5.00	
194-59555-17	Triangle block	4	\$3.00	
194-59555-18	Playfield block	2	\$3.00	
194-59555-19	Left leg	2	\$10.00	
194-59555-20	Right leg	2	\$10.00	
194-59555-21	Side leg panel	2	\$7.50	
194-59555-22	End leg panel	2	\$7.50	
194-59555-25	1/8" round head screw	10	\$1.00	
194-59555-26	Handle bolt	10	\$1.00	
194-59555-27	Rod stopper bolt	10	\$1.00	
194-59555-28	Rod stopper nut	20	\$1.00	
194-59555-29	Leg bolt	12	\$1.00	
194-59555-30	Leg washer	24	\$1.00	
194-59555-31	Leg nut	12	\$1.00	
194-59555-32	Black Phillips head screw	4	\$1.00	
194-59555-33	Goalie iron bar	2	\$3.00	
194-59555-34	1/4" round head screw	20	\$1.00	
194-59555-35	Flat washer	2	\$1.00	
194-59555-36	Goalie rod bolt	2	\$1.00	
194-59555-37	Goalie rod nut	2	\$1.00	
194-59555-38	7/8" Phillips head screw	4	\$1.00	
194-59555-39	1/2" round head screw	20	\$1.00	
194-59555-40	NHL sticker sheet	1	\$5.00	
194-59555-41	5/8" white Phillips head screw	12	\$1.00	
300-10041	Electronic scorer	1	\$10.00	

Also be sure to check out our web site at:

www.regent-halex.com

• Parts Ordering • Owners Manual • Product Information



© 2004
Regent Sports Corporation
Hauppauge, New York