

Halex Halex Halex Ha  
lex Halex Halex Halex  
Halex Halex Halex Ha  
lex Halex Halex Halex  
Halex Halex Halex Ha  
lex Halex Halex Halex  
Halex Halex Halex Ha  
lex Halex Halex Halex  
Halex Halex Halex Ha

TABLE  
**Games**

*Assembly instructions*



59555 (2005)

*Handwritten scribble and signature*

## **LIMITED 90 DAY WARRANTY**

This Halex product is warranted to be free from defects in workmanship or materials at the time of purchase for a period of 90 (ninety) days. Certain restrictions apply (see below).

Should any evidence of defects appear within the limited warranty period after the date of purchase, Regent Sports will either send replacement parts or advise of another course of action. A list of replaceable parts can be found on the parts order form page of this manual. Parts not listed on this order form are not replaceable. **Table tops, playing surfaces, and main frames are not replaceable.** This warranty covers normal consumer use and does not cover failures, which result from alterations, accidents, misuse, abuse, or neglect.

For prompt warranty service and special offers, please register your Halex product at our customer service center by visiting our website at: [www.regent-halex.com](http://www.regent-halex.com). Enter the following unique registration number followed by the item number of your table found on the cover of this manual: 1ZAK7 \_\_\_\_\_. You must register your product within 30 days of purchase to be eligible for warranty service. Please make sure to visit our website to order additional parts not covered under the warranty, as well as on-line instruction manuals and new product information. You may also order parts by calling our automated voice recognition system at: 877-516-9707 (Toll Free).

**A purchase receipt or other proof of date of purchase will be required before warranty service is performed.** Requests for warranty service can be provided by e-mailing the customer service department at [cstables@regent-halex.com](mailto:cstables@regent-halex.com) or by calling customer service at:

**877-516-9707 (Toll Free)**

**10:00 AM to 6:00 PM, EST. (Dec. through Jan.)**

















**10:00 AM to 5:00 PM, EST. (Feb. through Nov.)**





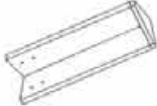



Or send request in writing to:

**Regent Sports Corporation**  
45 Ranick Road  
Hauppauge, NY 11788  
Attn: Halex Customer Service

This warranty gives you specific legal rights and you may have other rights that vary from state to state.

# 59555 ROD HOCKEY PARTS LIST

<p>#1</p>  <p>Hockey Puck 4Pieces</p>	<p>#2</p>  <p>Hockey Goal 2Pieces</p>	<p>#3</p>  <p>Red Short Stick Player 1Piece</p>	<p>#4</p>  <p>Red Long Stick Player 4Pieces</p>
<p>#5</p>  <p>Red Goalie 1Piece</p>	<p>#6</p>  <p>Blue Short Stick Player 1Piece</p>	<p>#7</p>  <p>Blue Long Stick Player 4Pieces</p>	<p>#8</p>  <p>Blue Goalie 1Piece</p>
<p>#9</p>  <p>Manual Scorer 2Pieces</p>	<p>#10</p>  <p>Rod Handles 10Pieces</p>	<p>#11</p>  <p>Short Rod 4Pieces</p>	<p>#12</p>  <p>Medium Rod A 2Pieces</p>
<p>#13</p>  <p>Medium Rod B 2Pieces</p>	<p>#14</p>  <p>Long Rod 2Pieces</p>	<p>#15</p>  <p>Rod Bushing 10Pieces</p>	<p>#16</p>  <p>Gear Mechanism 10Pieces</p>
<p>#17</p>  <p>Foam Spacer 10Pieces</p>	<p>#18</p>  <p>Rod Stopper 10Pieces</p>	<p>#19</p>  <p>Leg 4Pieces</p>	<p>#20</p>  <p>Support Brace 1Pieces</p>
<p>#21</p>  <p>Long Legs Abdomen Board 2Pieces</p>	<p>#22</p>  <p>Short Legs Abdomen Board 2Pieces</p>	<p>#23</p>  <p>Open End Wrench 1Pieces</p>	<p>#24</p>  <p>Tool 1Piece</p>

<p>#25</p>  <p>M3 Bolt 10 Pieces</p>	<p>#26</p>  <p><math>\frac{5}{32}</math>" Bolt 10 Pieces</p>	<p>#27</p>  <p>M3 Nut 10 Pieces</p>	<p>#28</p>  <p><math>\frac{5}{32}</math>" Nut 10 Pieces</p>
<p>#29</p>  <p>M6 Bolt 16 Pieces</p>	<p>#30</p>  <p>M6 Flat Washer 16 Pieces</p>	<p>#31</p>  <p>3.0mm Flat Head Screw 8 Pieces</p>	<p>#32</p>  <p>Goalie Control 2 Pieces</p>
<p>#33</p>  <p>M4 Bolt 2 Pieces</p>	<p>#34</p>  <p>M4 Flat Washer 2 Pieces</p>	<p>#35</p>  <p>M4 Nut 2 Pieces</p>	<p>#36</p>  <p>2.5mm Round Head Screw 20 Pieces</p>
<p>#37</p>  <p>3.5mm Round Head Screw 20 Pieces</p>	<p>#38</p>  <p>Electron Scorer 1 Piece</p>	<p>#39</p>  <p>2.5mm Round Head Screw 2 Pieces</p>	<p>#40</p>  <p>NHL Sticker NHL Paster 1 Piece</p>

**STEP 1** – Assemble rods following the number order in the diagram. First, slide rod through the hole in the end panel. Next, slide on Foam Spacer # 17 on to rod. Then, attach Rod Stopper # 18 on rod using screws # 26 & 28. Insert Gear Mechanism #16 into track, then attach the end of the Rod to the Gear using screws #36. Next, slide Rod Bushing #15 on the rod. Attach Handle # 10 with Bolt # 25 and Nut # 27. Repeat for all Rods until complete.

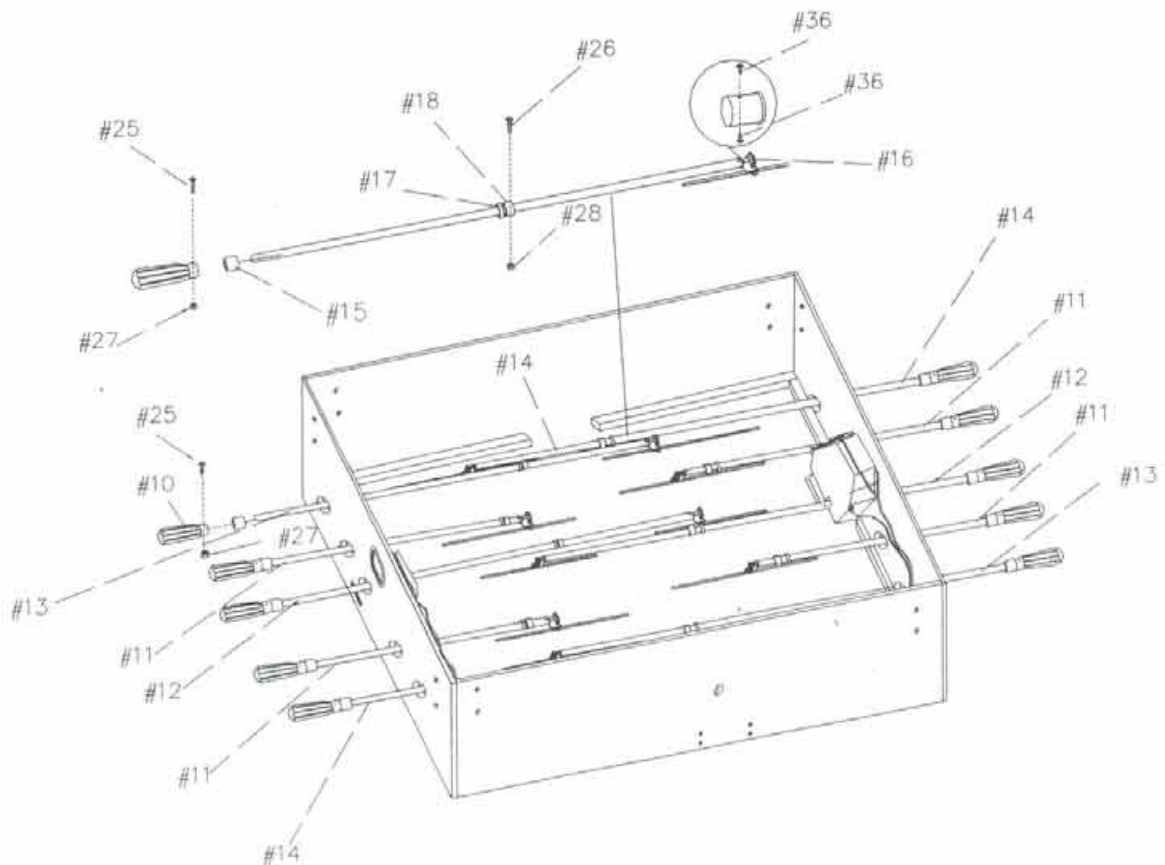

**Step 2-** Attach Legs #19 to table using Bolts #29 and Washers #30. Then, attach Support Brace #20, using Screws #37. Next, attach Leg Panel #21 and #22 to legs using screws #37.

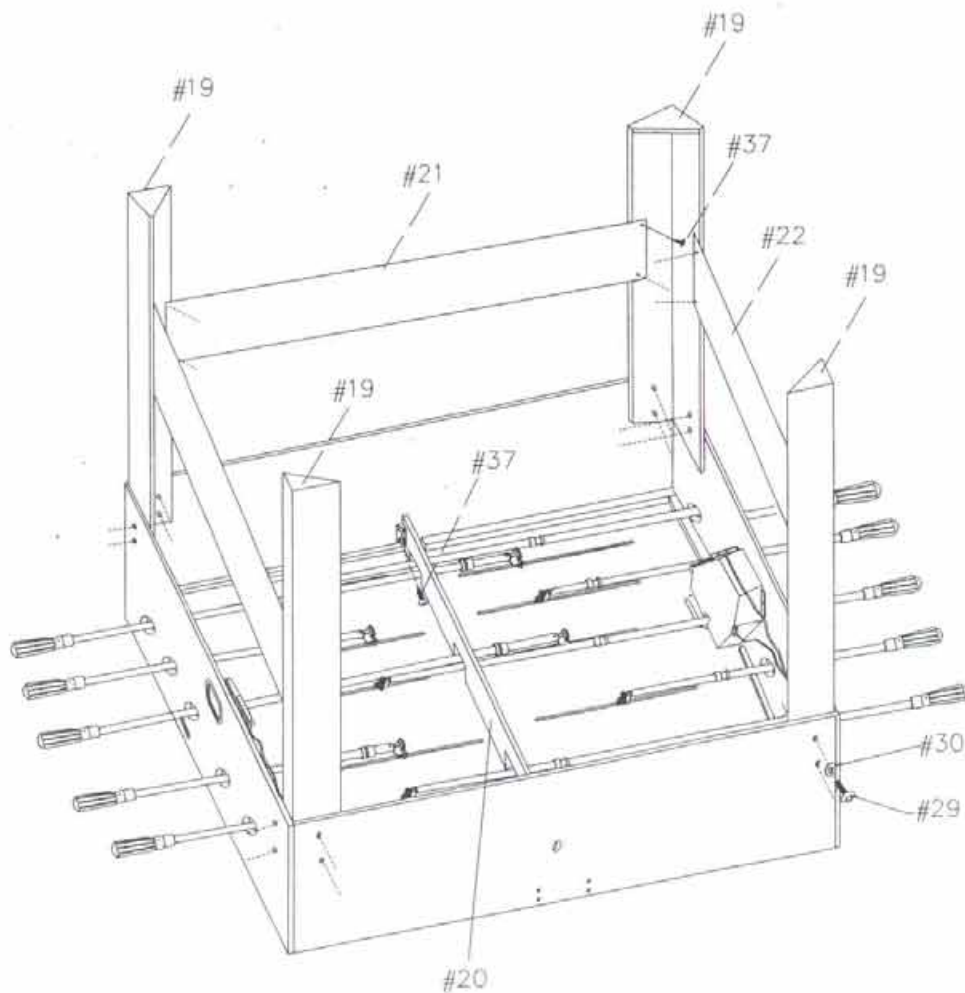

**Step 3-** Place each player on table rods. See diagram for proper placement. Next Slide Goalie Control #32 into the slot into the end panel. Secure with Screw #33, Washer #34 and Nut #35. For Goalies #8 and #5 secure with Screw #39. Attach Manual Scorer #9 to the table using flat head screw #31.

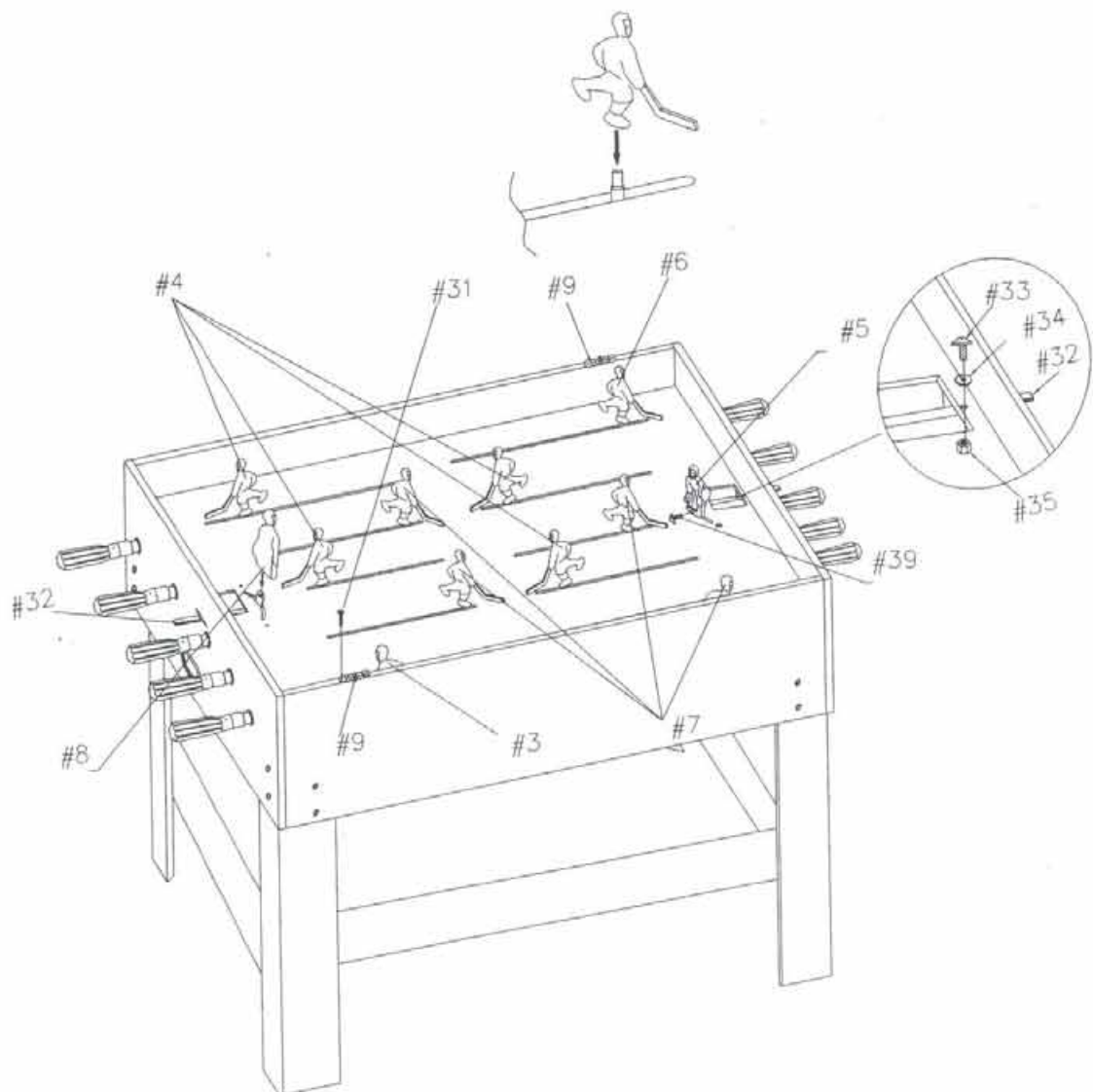

**Step 4-** Attach Electronic Scoring Unit #38 to the side panel using Screws # 31. Next attach goal # 2 to each end of the play surface. Attach goal sensor wires to back of unit.

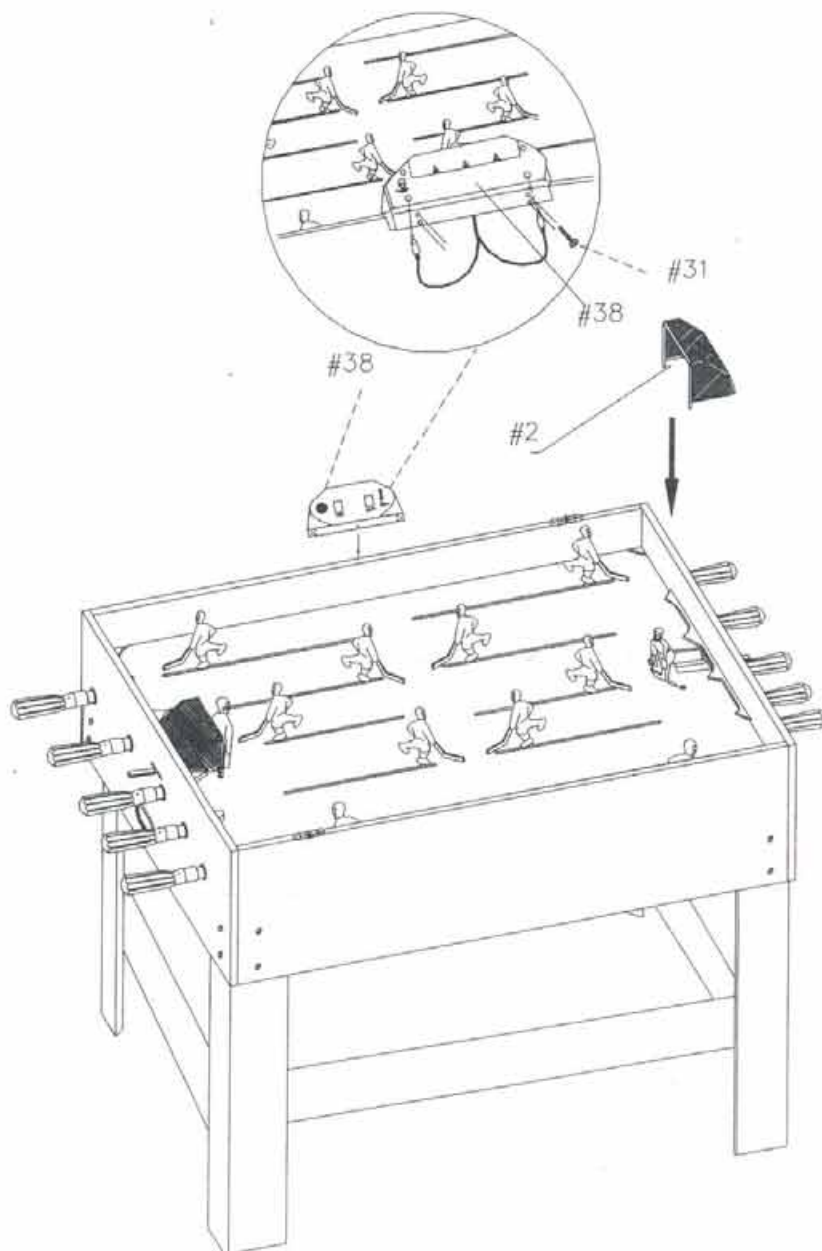

## PARTS ORDER FORM

If for some reason you are missing any assembly parts for your Halex game table, please call the Regent Sports Customer Service line at (1-877) 516-9707 (toll free) between the hours of 10:00am and 5:00 pm EST or go online at [www.regent-halex.com](http://www.regent-halex.com) for parts ordering. Please refer to the REGENT SPORTS LIMITED WARRANTY concerning missing and defective parts.

Parts also may be ordered by filling out the form below. Please fill in all the information and return to:

REGENT SPORTS CORP.  
45 RANICK ROAD  
HAUPPAUGE, NEW YORK, 11788  
ATTN: CUSTOMER SERVICE

REGENT SPORTS CORP. requires that all orders for replacement parts must be paid by check, money order, VISA, or MC. Cash is not accepted. Please make all checks or money orders payable to REGENT SPORTS CORP. *Please note all prices include shipping and handling.*

Name of Purchaser: \_\_\_\_\_  
Address: \_\_\_\_\_  
City: \_\_\_\_\_  
State: \_\_\_\_\_ Zip Code: \_\_\_\_\_  
Phone: \_\_\_\_\_

Part #	Description	Quantity	Price	Total Cost
195-59555-01	Hockey Puck	4	\$2.00	
195-59555-02	Hockey Goal	2	\$5.00	
195-59555-03	Red Short Stick Player	1	\$5.00	
195-59555-04	Red Long Stick Player	4	\$5.00	
195-59555-05	Red Goalie	1	\$5.00	
195-59555-06	Blue Short Stick Player	1	\$5.00	
195-59555-07	Blue Long Stick Player	4	\$5.00	
195-59555-08	Blue Goalie	1	\$5.00	
195-59555-09	Manual Scorer	2	\$5.00	
195-59555-10	Rod Handles	10	\$3.00	
195-59555-11	Short Rod	4	\$5.00	
195-59555-12	Medium Rod A	2	\$5.00	
195-59555-13	Medium Rod B	2	\$5.00	
195-59555-14	Long Rod	2	\$5.00	
195-59555-15	Rod Bushing	10	\$1.00	
195-59555-16	Gear Mechanism	10	\$5.00	
195-59555-17	Foam Spacer	10	\$1.00	
195-59555-18	Rod Stopper	10	\$1.00	
195-59555-19	Leg	4	\$12.50	
195-59555-20	Support Brace	1	\$5.00	
195-59555-21	Side Leg Panel	2	\$7.50	
195-59555-22	End Leg Panel	2	\$7.50	
195-59555-25	M3 Bolt	10	\$1.00	

195-59555-26	5/32" Bolt	10	\$1.00	
195-59555-27	M3 Nut	10	\$1.00	
195-59555-28	5/32" Nut	10	\$1.00	
195-59555-29	M6 Bolt	16	\$1.00	
195-59555-30	M6 Flat Washer	16	\$1.00	
195-59555-31	3mm Flat Head Screw	8	\$1.00	
195-59555-32	Goalie Control	2	\$3.00	
195-59555-33	M4 Bolt	2	\$1.00	
195-59555-34	M4 Flat Washer	2	\$1.00	
195-59555-35	M4 Nut	2	\$1.00	
195-59555-36	2.5mm Round Head Screw	20	\$1.00	
195-59555-37	3.5mm Round Head Screw	20	\$1.00	
195-59555-38	Electronic Scorer	1	\$1 <del>0.00</del>	
195-59555-39	2.5mm Round Head Screw	2	\$1.00	
195-59555-40	NHL Sticker Sheet	1	\$5.00	