

**Games**

***Assembly instructions***

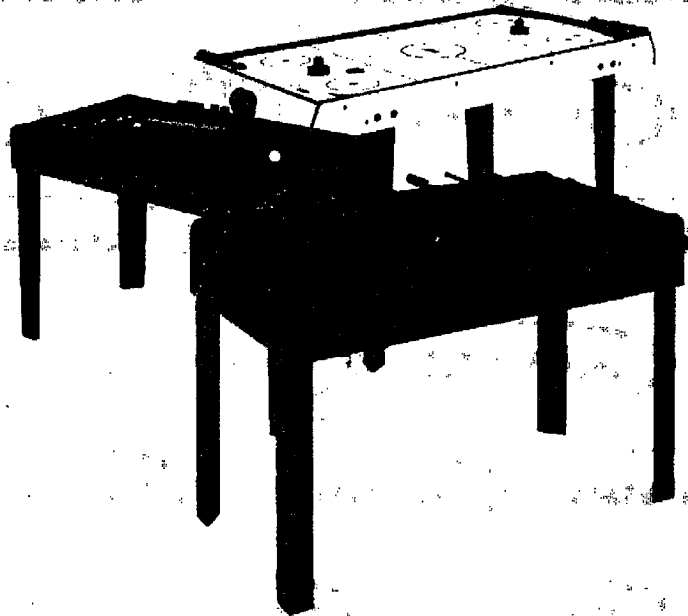

**Halex**

TM

50895

**Should you have a defect or parts issue, please refer to the warranty instructions listed below and contact Regent Sports at our toll free number!!**

**LIMITED 90 DAY WARRANTY**

This Halex product is warranted to be free from defects in workmanship or materials at the time of purchase for a period of 90 (ninety) days. Certain restrictions apply (see below).

Should any evidence of defects appear within the limited warranty period after the date of purchase, Regent Sports will either send replacement parts or advise of another course of action. A list of replaceable parts can be found on the parts order form page of this manual. Parts not listed on this order form are not replaceable. **Table tops, playing surfaces, and main frames are not replaceable.** This warranty covers normal consumer use and does not cover failures, which result from alterations, accidents, misuse, abuse, or neglect.

For prompt warranty service and special offers, please register your Halex product at our customer service center by visiting our website at: [www.regent-halex.com](http://www.regent-halex.com). Enter the following unique registration number followed by the item number of your table found on the cover of this manual: 1ZAK7 \_\_\_\_\_. You must register your product within 30 days of purchase to be eligible for warranty service. Please make sure to visit our website to order additional parts not covered under the warranty, as well as on-line instruction manuals and new product information. You may also order parts by calling our automated voice recognition system (877) 516-8707.

**A purchase receipt or other proof of date of purchase will be required before warranty service is performed.** Requests for warranty service can be provided by e-mailing the customer service department at [cstables@regent-halex.com](mailto:cstables@regent-halex.com) or by calling customer service at:

**877-516-9707 (Toll Free)**

**10:00 AM to 6:00 PM, EST. (Dec. through Jan.)**









**10:00 AM to 5:00 PM, EST. (Feb. through Nov.)**

Or send request in writing to:

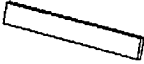
**Regent Sports Corporation**  
45 Ranick Road  
Hauppauge, NY 11788  
Attn: Halex Customer Service

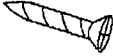
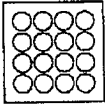
This warranty gives you specific legal rights and you may have other rights that vary from state to state.

## 50895 PARTS LIST & ASSEMBLY

<p>#1</p>  <p>Main cabinet 1 Piece</p>	<p>#2</p>  <p>Left Leg 2 Pieces</p>	<p>#3</p>  <p>Right Leg 2 Pieces</p>	<p>#4</p>  <p>Leg Panel 2 Pieces</p>
<p>#5</p>  <p>1/4" Leg bolt 4 Pieces</p>	<p>#6</p>  <p>1/4" Washer 4 Pieces</p>	<p>#7</p>  <p>F4*1-3/4" Screw 8 Pieces</p>	<p>#8</p>  <p>Pool balls 1 Set</p>
<p>#9</p>  <p>Allen Key 1 Piece</p>	<p>#10</p>  <p>Cue stick 2 Pieces</p>	<p>#11</p>  <p>Triangle rack 1 Piece</p>	<p>#12</p>  <p>Cue chalk 2 Pieces</p>

### STEP:1

Lay table down on a clean dry surface. Next attach the Leg Pieces #2 & #3 to the Main Cabinet #1 using Leg Bolt #5 and Washer #6 using Allen Key #9. Next attach the Leg Panel #4 to the Leg Pieces using F4 Screw #7.

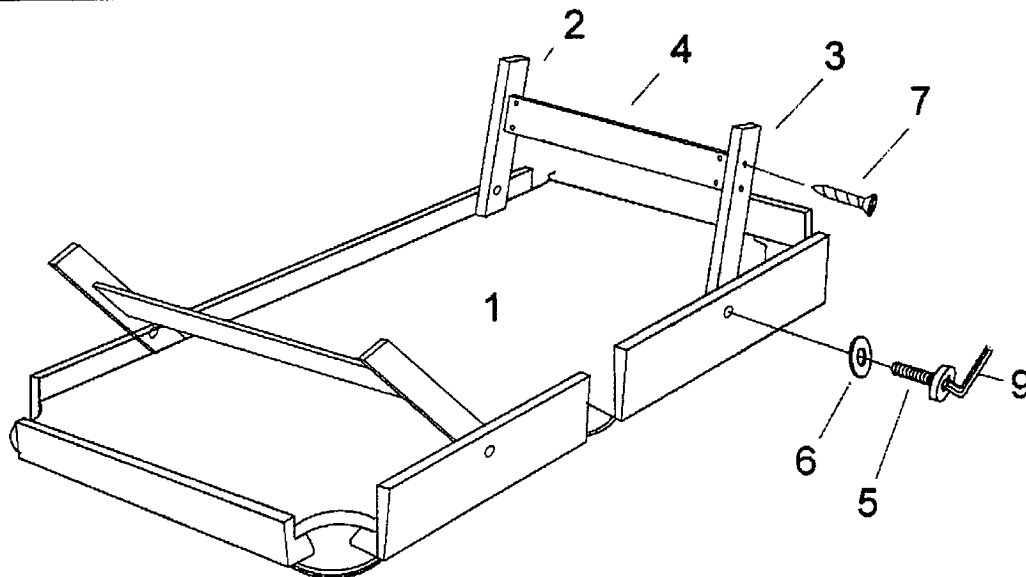

## PARTS ORDER FORM

If for some reason you are missing any assembly parts for your Halex game table, please call the Regent Sports Customer Service line at (1877) 516-9707 (toll free) between the hours of 10:00am and 5:00 pm EST or go online at [www.regent-halex.com](http://www.regent-halex.com) for parts ordering. Please refer to the REGENT SPORTS LIMITED WARRANTY concerning missing and defective parts.

Parts also may be ordered by filling out the form below. Please fill in all the information and return to:

REGENT SPORTS CORP.  
45 RANICK ROAD  
HAUPPAUGE, NEW YORK, 11788  
ATTN: CUSTOMER SERVICE

REGENT SPORTS CORP. requires that all orders for replacement parts must be paid by check, money order, VISA, or MC. Cash is not accepted. Please make all checks or money orders payable to REGENT SPORTS CORP.

*Please note all prices include shipping and handling.*

Name of Purchaser: \_\_\_\_\_

Address: \_\_\_\_\_

City: \_\_\_\_\_

State: \_\_\_\_\_ Zip Code: \_\_\_\_\_

Phone: \_\_\_\_\_

Part #	Description	Quantity	Price	Total Cost
196-50895-02	Left leg	2	\$15.00 ea.	
196-50895-03	Right leg	2	\$15.00 ea.	
196-50895-04	Leg panel	2	\$13.50 ea.	
196-50895-05	Leg bolt 5/16"	4	\$1.25 ea.	
196-50895-06	Washer 1/4"	4	\$1.25 ea.	
196-50895-07	F4 Screw 1-3/4"	8	\$1.25 ea.	
196-50895-08	Billiard Ball	1	\$25.00 set	
196-50895-09	Allen Key	1	\$1.25 ea.	
196-50895-10	Cue stick	2	\$15.00 ea.	
196-50895-11	Triangle rack	1	\$7.00 ea.	
196-50895-12	Cue chalk	2	\$2.00 ea.	

**Also be sure to check out our web site at:**

**[www.regent-halex.com](http://www.regent-halex.com)**

• Parts Ordering • Owners Manual • Product Information



© 2006  
Regent Sports Corporation  
Hauppauge, New York