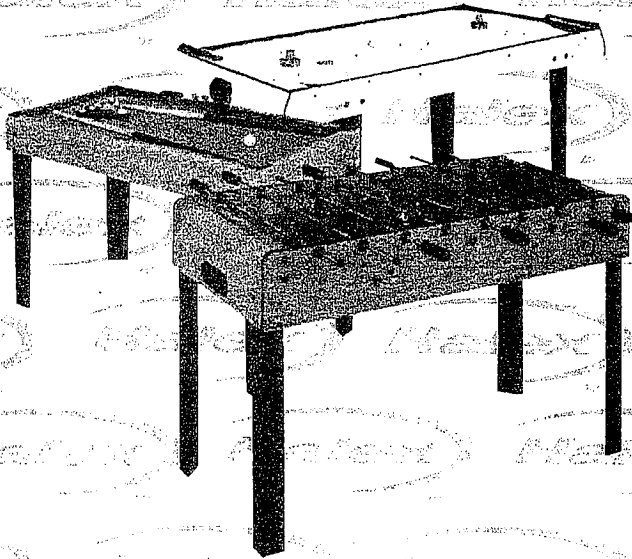

TABLE
Games

Assembly instructions



50731

PLEASE DO NOT RETURN THIS ITEM TO THE STORE!

Should you have a defect or parts issue, please refer to the warranty instructions listed below and contact Regent Sports at our toll free number!!

LIMITED 90 DAY WARRANTY

This Halex product is warranted to be free from defects in workmanship or materials at the time of purchase for a period of 90 (ninety) days. Certain restrictions apply (see below).

Should any evidence of defects appear within the limited warranty period after the date of purchase, Regent Sports will either send replacement parts or advise of another course of action. A list of replaceable parts can be found on the parts order form page of this manual. Parts not listed on this order form are not replaceable. **Table tops, playing surfaces, and main frames are not replaceable.** This warranty covers normal consumer use and does not cover failures, which result from alterations, accidents, misuse, abuse, or neglect.

For prompt warranty service and special offers, please register your Halex product at our customer service center by visiting our website at: www.regent-halex.com. Enter the following unique registration number followed by the item number of your table found on the cover of this manual: 1ZAK7 _____. You must register your product within 30 days of purchase to be eligible for warranty service. Please make sure to visit our website to order additional parts not covered under the warranty, as well as on-line instruction manuals and new product information. You may also order parts by calling our automated voice recognition system (877) 516-8707.

A purchase receipt or other proof of date of purchase will be required before warranty service is performed. Requests for warranty service can be provided by e-mailing the customer service department at cstables@regent-halex.com or by calling customer service at:

877-516-9707 (Toll Free)

10:00 AM to 6:00 PM, EST. (Dec. through Jan.)

10:00 AM to 5:00 PM, EST. (Feb. through Nov.)











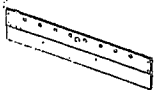

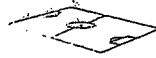

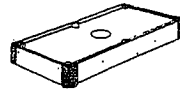
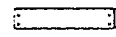

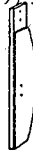





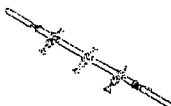

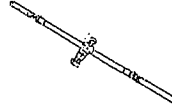
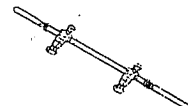
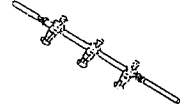
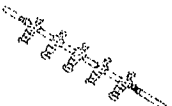



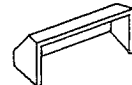

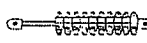
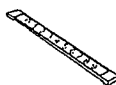
Or send request in writing to:

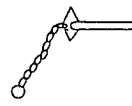

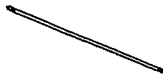
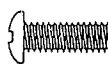



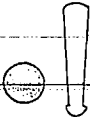
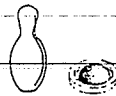
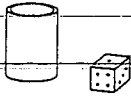

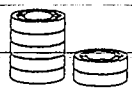





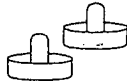



Regent Sports Corporation
45 Ranick Road
Hauppauge, NY 11788
Attn: Halex Customer Service

This warranty gives you specific legal rights and you may have other rights that vary from state to state.

PART IDENTIFIER

ITEM NO: 50731

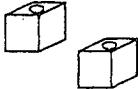
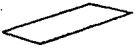
<p>① (197-50731-01)</p>  <p>SOCCER SIDE APRON 2EA</p>	<p>② (197-50731-02)</p>  <p>SOCCER END APRON 2EA</p>	<p>③ (197-50731-03)</p>  <p>SOCCER PLAYFIELD 1EA</p>	<p>④ (197-50731-04)</p>  <p>SUPPORT 2EA</p>	<p>⑤ (197-50731-05)</p>  <p>BILLIARD TABLE ASSEMBLY 1EA</p>	<p>⑥ (197-50731-06)</p>  <p>LEG PANEL 2EA</p>
<p>⑦ (197-50731-07)</p>  <p>LEFT LEG 2EA</p>	<p>⑧ (197-50731-08)</p>  <p>RIGHT LEG 2EA</p>	<p>⑨ (197-50731-09)</p>  <p>CHECKER/SHUFFLEBALL/ BOWLING GAME SURFACE 1EA</p>	<p>⑩ (197-50731-10)</p>  <p>SLIDE HOCKEY 1EA</p>	<p>⑪ (197-50731-11)</p>  <p>BILLIARD SURFACE 1EA</p>	<p>⑫ (197-50731-12)</p>  <p>1 HOLE PLAYER ROD - RED/WHITE PLAYER 1EA</p>
<p>⑬ (197-50731-13)</p>  <p>2 HOLE PLAYER ROD - RED/WHITE PLAYER 1EA</p>	<p>⑭ (197-50731-14)</p>  <p>3 HOLE PLAYER ROD - RED/WHITE PLAYER 1EA</p>	<p>⑮ (197-50731-15)</p>  <p>5 HOLE PLAYER ROD - RED/WHITE PLAYER 1EA</p>	<p>⑯ (197-50731-16)</p>  <p>1 HOLE PLAYER ROD - BLUE/WHITE PLAYER 1EA</p>	<p>⑰ (197-50731-17)</p>  <p>2 HOLE PLAYER ROD - BLUE/WHITE PLAYER 1EA</p>	<p>⑱ (197-50731-18)</p>  <p>3 HOLE PLAYER ROD - BLUE/WHITE PLAYER 1EA</p>
<p>⑲ (197-50731-19)</p>  <p>5 HOLE PLAYER ROD - BLUE/WHITE PLAYER 1EA</p>	<p>⑳ (197-50731-20) PRE INSTALLED</p>  <p>STOP RING 4EA</p>	<p>㉑ (197-50731-21) PRE INSTALLED</p>  <p>RUBBER BUMPER 16EA</p>	<p>㉒ (197-50731-22) PRE INSTALLED</p>  <p>PLAYER BUSHING 16EA</p>	<p>㉓ (197-50731-23) PRE-INSTALLED</p>  <p>BALL ENTRY CUP 2EA</p>	<p>㉔ (197-50731-24) PRE-INSTALLED</p>  <p>GOAL 2EA</p>
<p>㉕ (197-50731-25) PRE INSTALLED</p>  <p>PLASTIC PLAYER ROD WASHER 16EA</p>	<p>㉖ (197-50731-26)</p>  <p>SOCCER SCORER - BLACK 2EA</p>	<p>㉗ (197-50731-27)</p>  <p>HOCKEY SCORER - BLACK 2EA</p>	<p>㉘ (197-50731-28)</p>  <p>4x50MM WASHER HEAD BOLT 8EA</p>	<p>㉙ (197-50731-29)</p>  <p>3.5x12mm WASHER HEAD SCREW 18EA</p>	<p>㉚ (197-50731-30)</p>  <p>CABINET LATCHES 2EA</p>
<p>㉛ (197-50731-31)</p>  <p>SUPPORT NUT 4EA</p>	<p>㉜ (197-50731-32)</p>  <p>SUPPORT ROD 2EA</p>	<p>㉝ (197-50731-33)</p>  <p>8x30mm ALLEN KEY LEG BOLT 8EA</p>	<p>㉞ (197-50731-34)</p>  <p>ROD END CAP 8EA</p>	<p>㉟ (197-50731-35)</p>  <p>3.5x25mm FLAT HEAD SCREW 4EA</p>	<p>㊱ (197-50731-36)</p>  <p>3.5x33mm FLAT HEAD SCREW 8EA</p>
<p>㊲ (197-50731-37)</p>  <p>HAND GRIP 8EA</p>	<p>㊳ (197-50731-38)</p>  <p>BASEBALL 1SET</p>	<p>㊴ (197-50731-39)</p>  <p>SHUFFLE BALLS & BOWLING PINA 1EA</p>	<p>㊵ (197-50731-40)</p>  <p>BACKGAMMON & DICE SET 1SET</p>	<p>㊶ (197-50731-41)</p>  <p>CHESS SET 1SET</p>	<p>㊷ (197-50731-42)</p>  <p>CHECKER SET 1SET</p>

<p>④③ (197-50731-43)</p>  <p>SOCCER BALL 4EA</p>	<p>④④ (197-50731-44) PRE INSTALLED</p>  <p>GOAL BOX 2EA</p>	<p>④⑤ (197-50731-45)</p>  <p>22MM FLAT WASHER 8EA</p>	<p>④⑥ (197-50731-46)</p>  <p>ROUND PUCK 2EA</p>	<p>④⑦ (197-50731-47)</p>  <p>PUSHER 2EA</p>	<p>④⑧ (197-50731-48)</p>  <p>PLASTIC HOCKEY STICK 2EA</p>
<p>④⑨ (197-50731-49)</p>  <p>FAN 1EA</p>	<p>⑤⑩ (197-50731-50)</p>  <p>LEG LEVELER 4 EA</p>	<p>⑤① (197-50731-51)</p>  <p>MINI HOCKEY 1SET.</p>	<p>⑤② (197-50731-52)</p>  <p>FOOSBALL 1SET</p>	<p>⑤③ (197-50731-53)</p>  <p>WRENCH 1EA</p>	<p>⑤④ (197-50731-54)</p>  <p>SOCCER CORNER LEFT 2EA</p>
<p>⑤⑤ (197-50731-55)</p>  <p>SOCCER CORNER RIGHT 2EA</p>	<p>⑤⑥ (197-50731-56)</p>  <p>CUE 2EA</p>	<p>⑤⑦ (197-50731-57)</p>  <p>BALL 1SET</p>	<p>⑤⑧ (197-50731-58)</p>  <p>TRIANGLE 1EA</p>	<p>⑤⑨ (197-50731-59)</p>  <p>CHALK 2EA</p>	<p>⑥⑩ (197-50731-60)</p>  <p>BASEBALL & FOOSBALL GAME SURFACE 1EA</p>
<p>⑥① (197-50731-61)</p>  <p>NAME PLATE 2EA</p>					

Step 1- Slide each Player Rod into End Panel (P1), following diagram for proper rod placement.

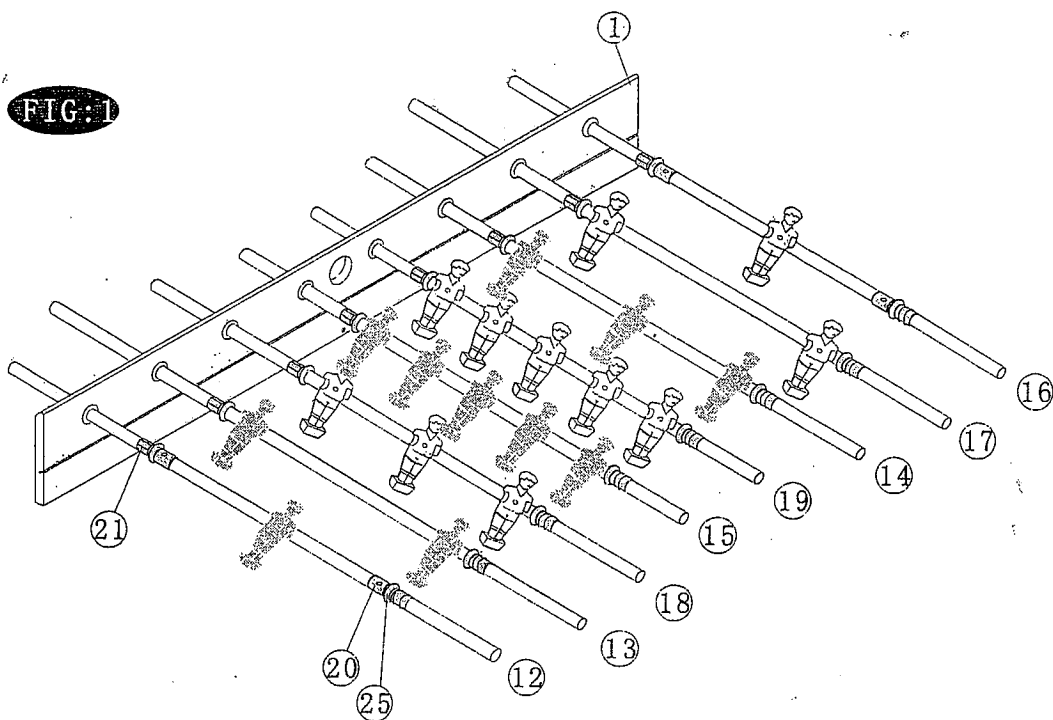

Step 2- Attach second Side Panel (P1) to the other side of the Player Rods. Turn assembly upside down and insert Playing Surface (P3). Once inserted, place End Panels (P2) onto each end.

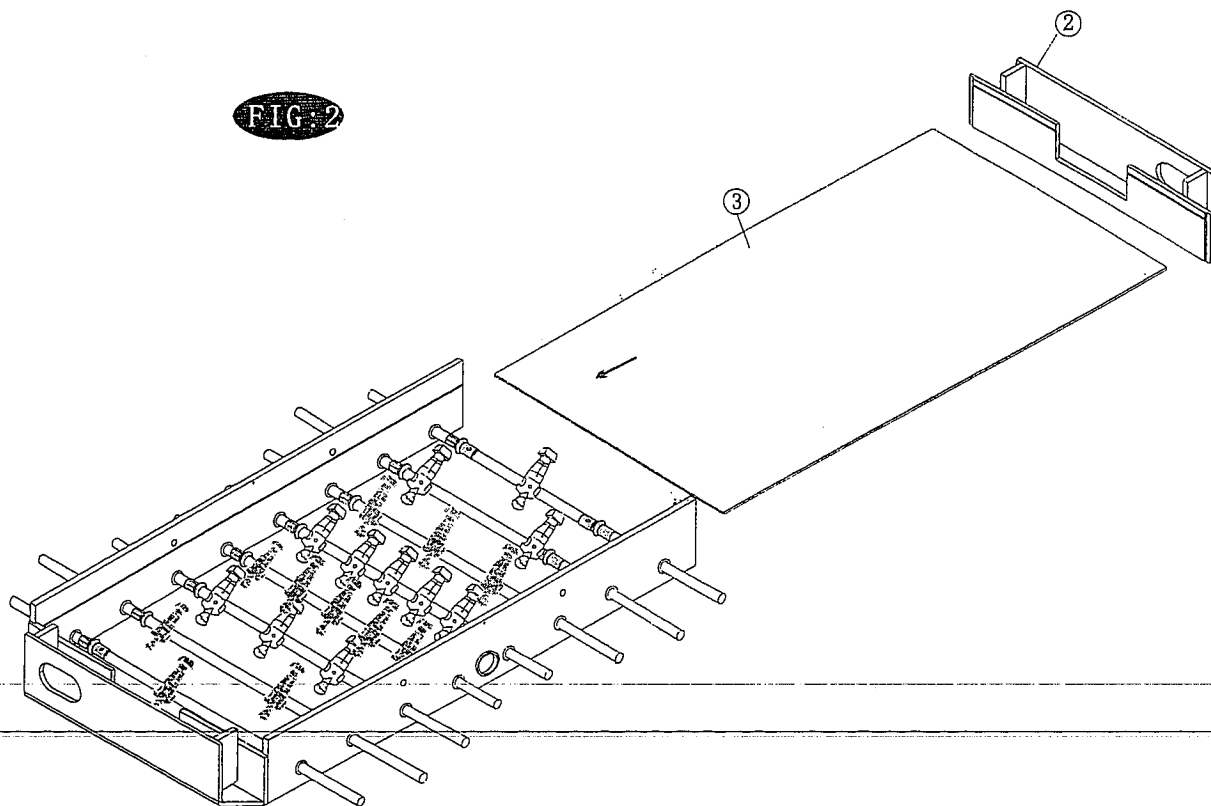

Step 3 Secure End Panels (P2) using Screws (P36). Next, attach Supports (P4) to the bottom of the table by sliding Support Rods (P32) through the pre-drilled holes and securing them with Support Rod Nut (P31).

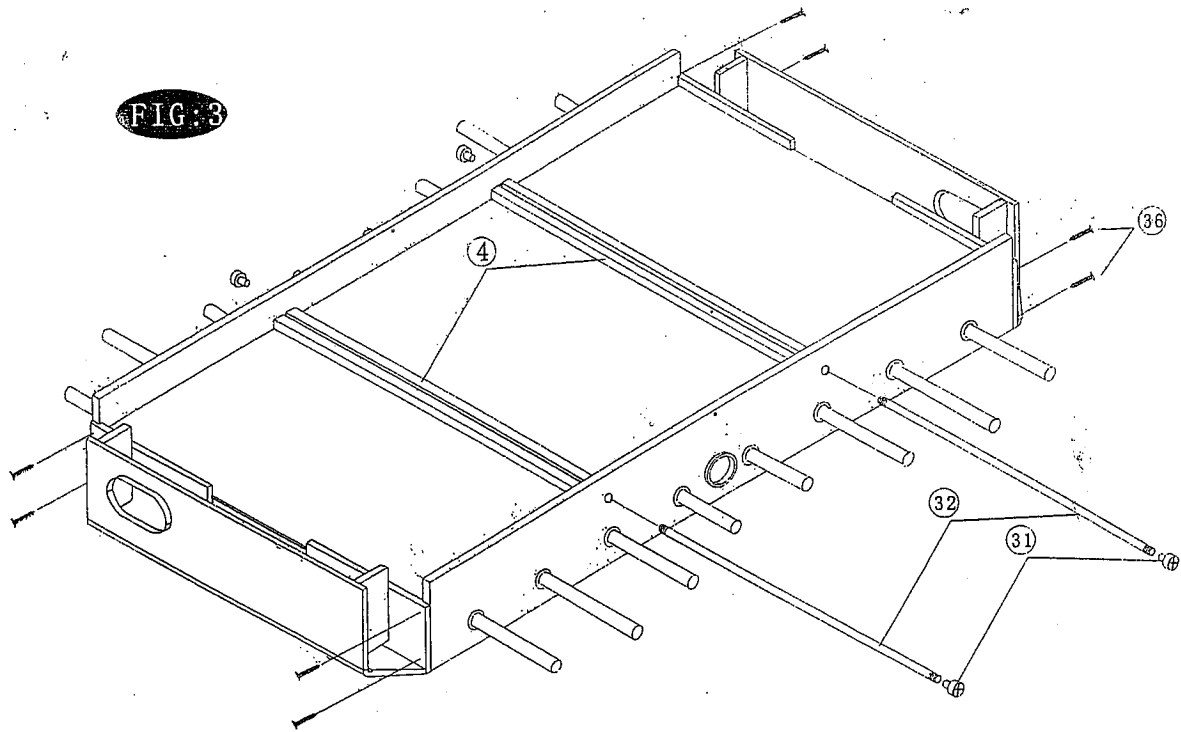

Step 4- Next, slide Corner Pieces (P54) and (P55) over each corner.

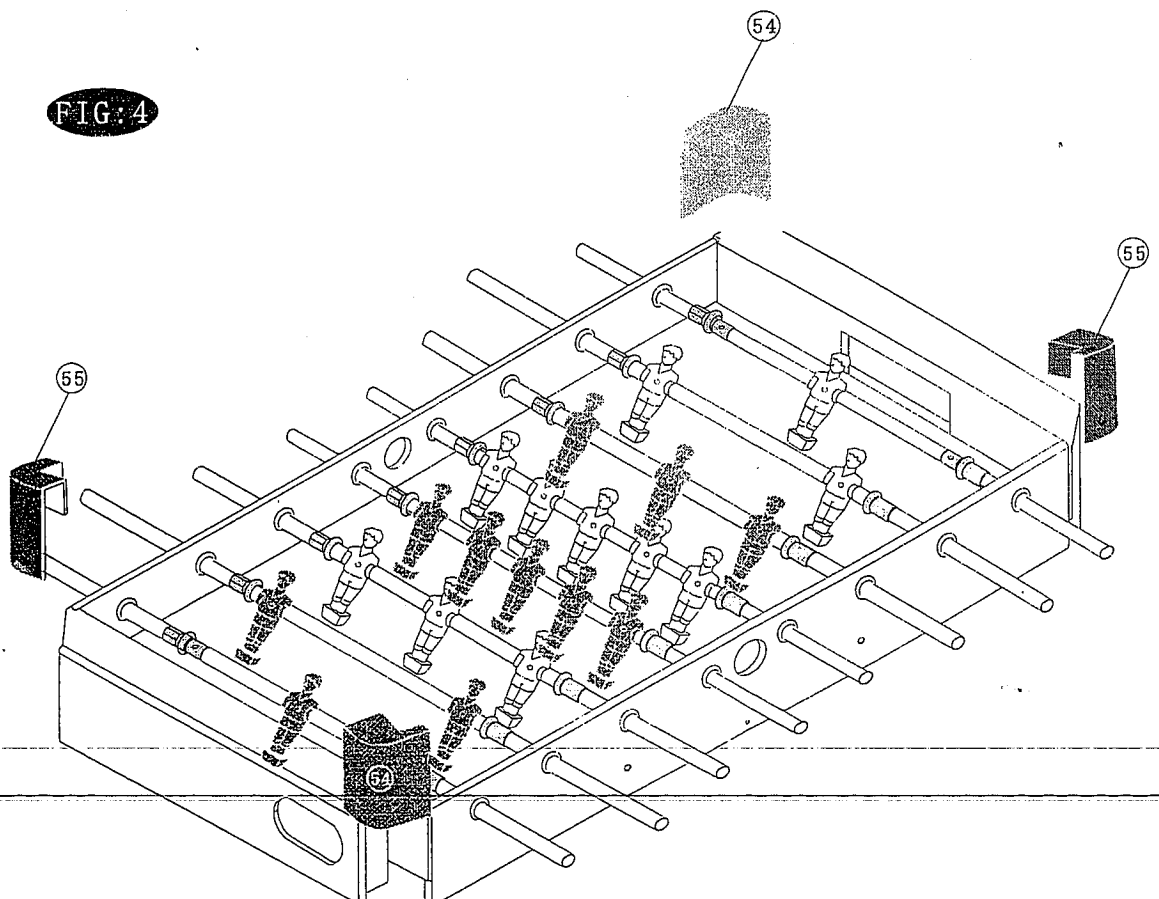

Step 5- Secure Corner Pieces with Screws (P29). Next, attach Manual Scoring (P26) using Screws (P35).

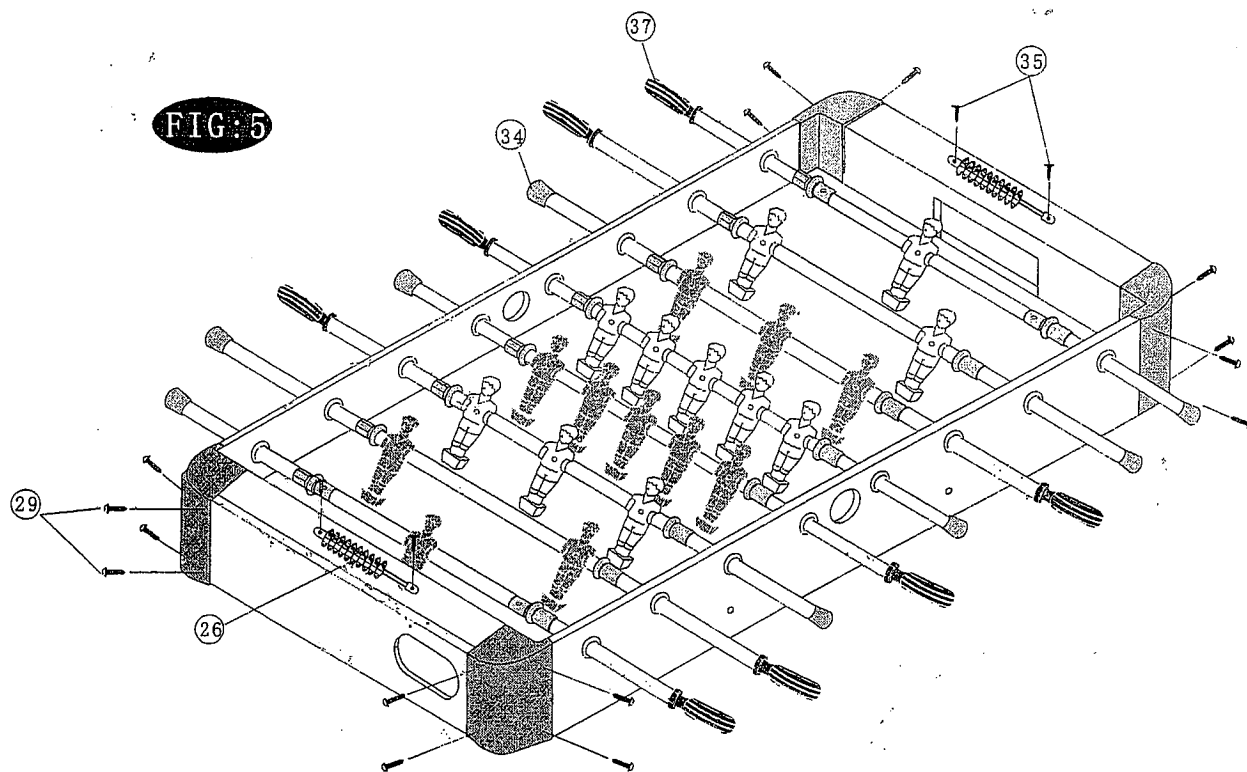

Step 6- Attach Legs (P7) and (P8) to the main frame of the table using Screws (P33) and Washers (P15). Next, attach Leg Panels (P6) to each leg assembly using Bolts (P28).

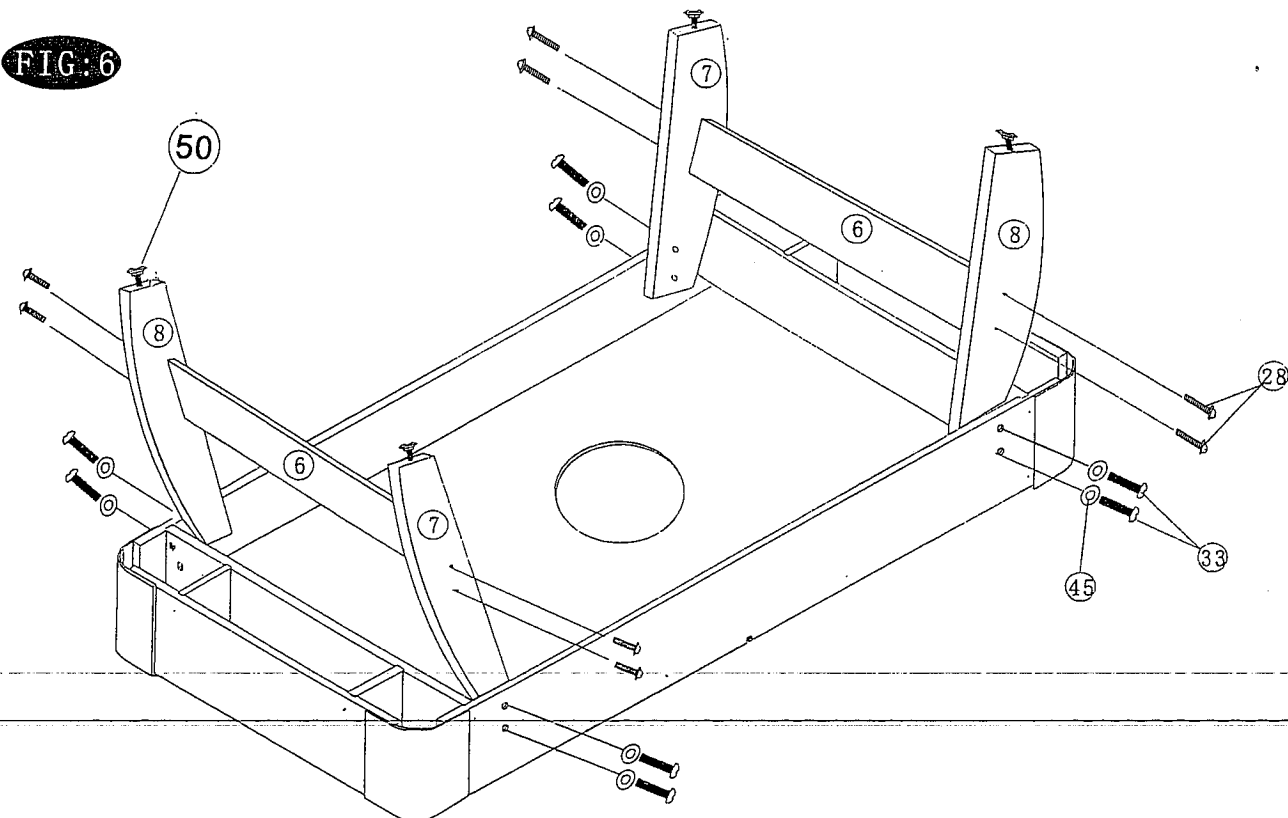

FIG: 7 BILLIARD GAME

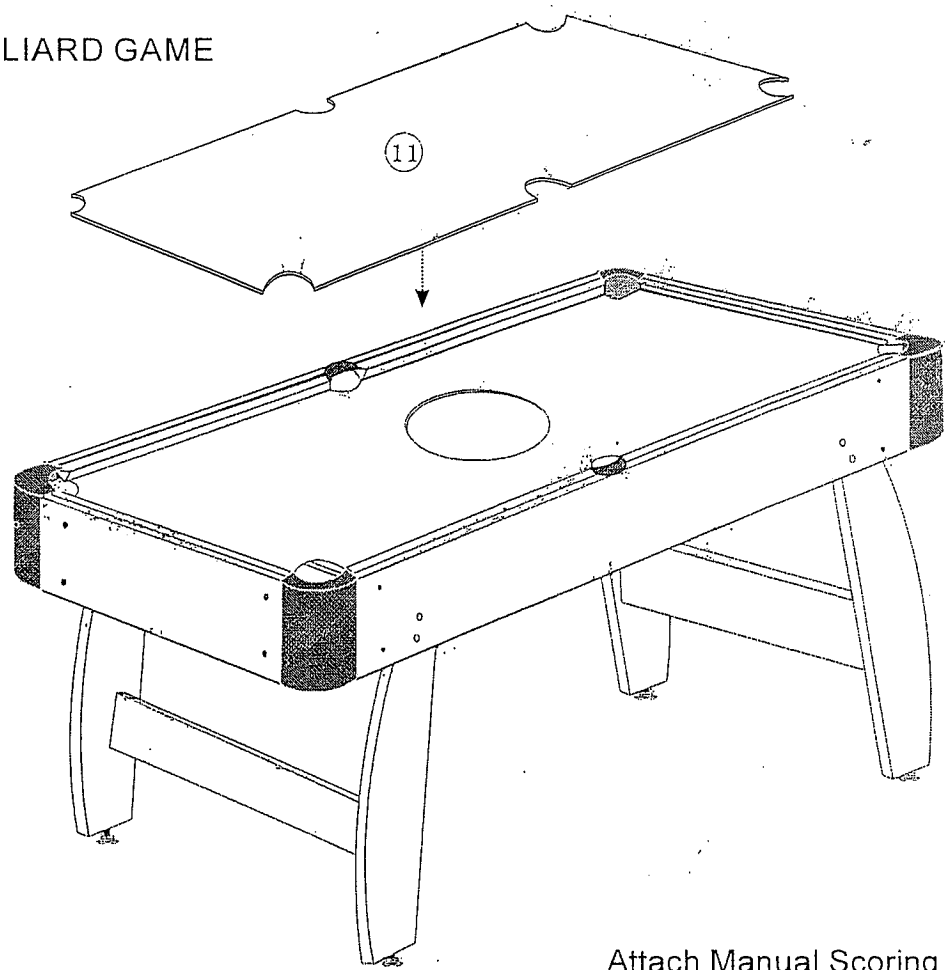

FIG: 8 AIR HOCKEY GAME

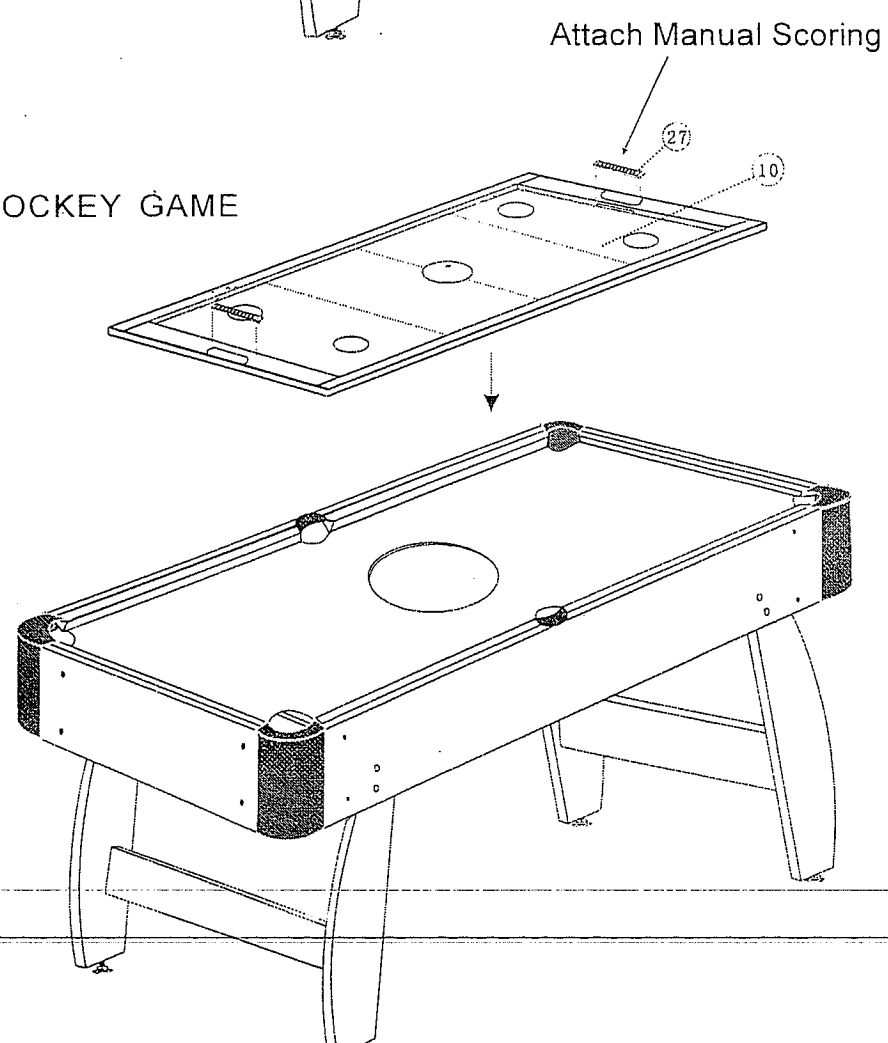

FIG. 9

BOWLING, CHECKER, CHESS, BACKGAMMON,
SHUFFLE BALL, MINI HOCKEY, STICK HOCKEY
BASEBALL, FOOSBALL

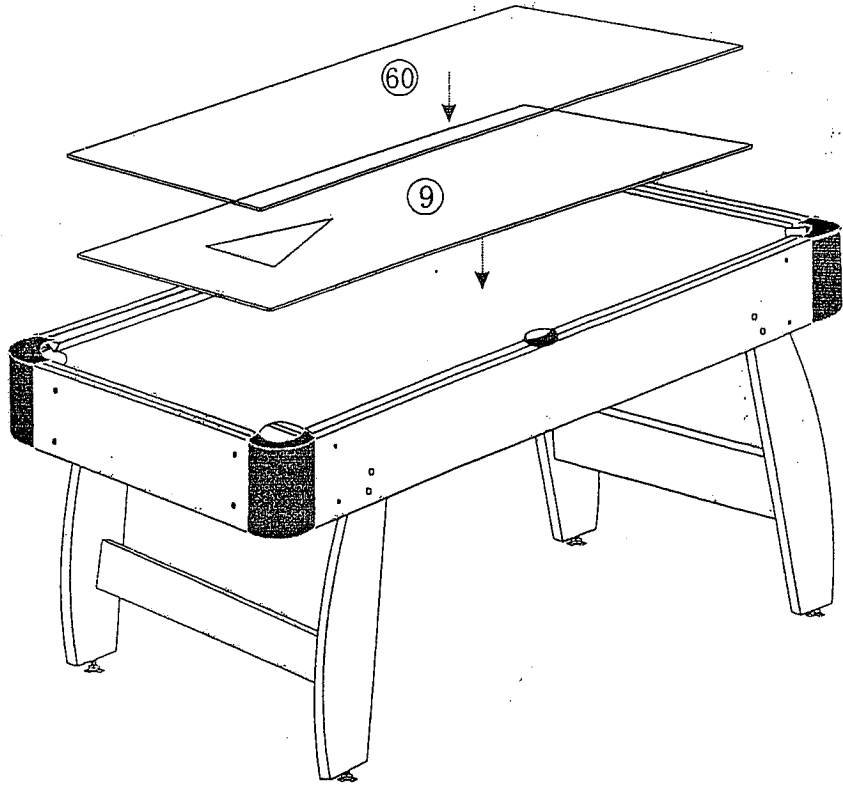
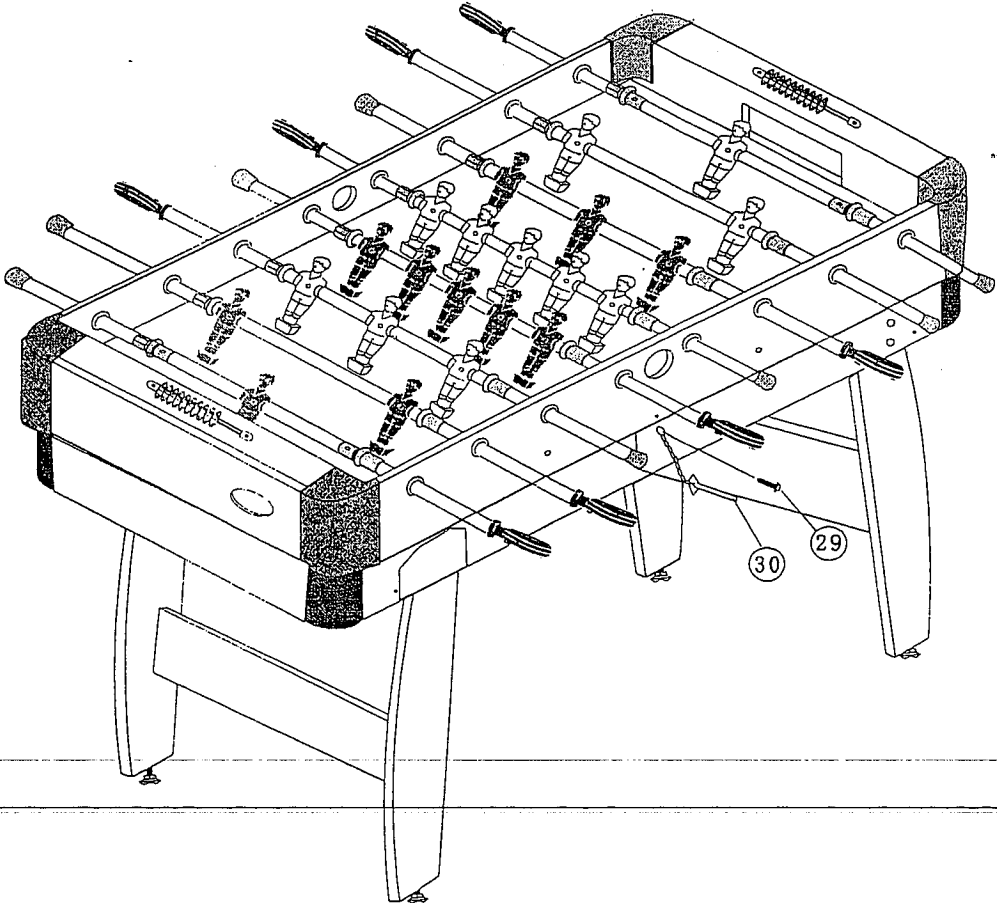

FIG. 10

SOCCER GAME



PARTS ORDER FORM

If for some reason you are missing any assembly parts for your Halex game table, please call the Regent Sports Customer Service line at (1-877) 516-9707 (toll free) between the hours of 10:00am and 5:00 pm EST or go online at www.regent-halex.com for parts ordering. Please refer to the REGENT SPORTS LIMITED WARRANTY concerning missing and defective parts.

Parts also may be ordered by filling out the form below. Please fill in all the information and return to:

REGENT SPORTS CORP.
45 RANICK ROAD
HAUPPAUGE, NEW YORK, 11788
ATTN: CUSTOMER SERVICE

REGENT SPORTS CORP. requires that all orders for replacement parts must be paid by check, money order, VISA, or MC. Cash is not accepted. Please make all checks or money orders payable to REGENT SPORTS CORP. *Please note all prices include shipping and handling.*

Name of Purchaser: _____
Address: _____
City: _____
State: _____ Zip Code: _____
Phone: _____

Part #	Description	Quantity	Price	Total Cost
197-50731-01	Soccer Side Apron	2	\$10.00	
197-50731-02	Soccer End Apron	2	\$10.00	
197-50731-03	Soccer Playfield	1	\$15.00	
197-50731-04	Support	2	\$4.00	
197-50731-06	Leg Panel	2	\$7.50	
197-50731-07	Left Leg	2	\$12.50	
197-50731-08	Right Leg	2	\$12.50	
197-50731-09	Checkers/Shuffleboard/Bowling Game Surface	1	\$10.00	
197-50731-10	Slide Hockey Surface	1	\$15.00	
197-50731-11	Billiard Surface	1	\$10.00	
197-50731-12	Red/White 1-Player Rod	1	\$10.00	
197-50731-13	Red/ White 2-Player Rod	1	\$10.00	
197-50731-14	Red/White 3-Player Rod	1	\$10.00	
197-50731-15	Red/White 5-Player Rod	1	\$10.00	
197-50731-16	Blue/White 1-Player Rod	1	\$10.00	
197-50731-17	Blue/White 2-Player Rod	1	\$10.00	
197-50731-18	Blue/White 3-Player Rod	1	\$10.00	
197-50731-19	Blue/White 5-Player Rod	1	\$10.00	
197-50731-26	Black Soccer Scorer	2	\$5.00	
197-50731-27	Hockey Scorer	2	\$5.00	
197-50731-28	4x50mm Washer Head Screw	8	\$1.00	
197-50731-29	3.5 x 12mm Screw	18	\$1.00	
197-50731-30	Cabinet Latches	2	\$2.00	
197-50731-31	Support Nut	4	\$1.00	
197-50731-32	Support Rod	2	\$4.00	
197-50731-33	8x30mm Screw	8	\$1.00	
197-50731-34	Rod End Cap	8	\$1.50	
197-50731-35	3.5x25mm Screw	4	\$1.00	

197-50731-36	3.5x33mm Screw	8	\$1.00	
197-50731-37	Handle	8	\$3.00	
197-50731-38	Baseball	1 Set	\$5.00	
197-50731-39	Shuffle Puck and Bowling Pins	1 Set	\$5.00	
197-50731-40	Backgammon and Dice	1 Set	\$5.00	
197-50731-41	Chess Set	1	\$5.00	
197-50731-42	Checker Set	1	\$3.50	
197-50731-43	Soccer Ball	4	\$5.00	
197-50731-45	22mm Leg Bolt Washer	8	\$1.00	
197-50731-46	Round Puck	2	\$1.00	
197-50731-47	Pusher	2	\$3.00	
197-50731-48	Hockey Stick	2	\$5.00	
197-50731-49	Fan	1	\$10.00	
197-50731-50	Leg Leveler	4	\$5.00	
197-50731-51	Mini Hockey	1	\$8.00	
197-50731-52	Foosball	1	\$8.00	
197-50731-53	Allen Key	1	\$1.00	
197-50731-54	Left Soccer Corner	2	\$5.00	
197-50731-55	Right Soccer Corner	2	\$5.00	
197-50731-56	Cue Stick	2	\$10.00	
197-50731-57	Billiard Balls	1 Set	\$15.00	
197-50731-58	Triangle	1	\$3.00	
197-50731-59	Chalk	2	\$2.00	
197-50731-60	Baseball & Foosball Game Board	1	\$10.00	

Also be sure to check out our web site at:

WWW.regent-halex.com

• Parts Ordering • Owners Manual • Product Information



© 2007
Regent Sports Corporation
Hauppauge, New York