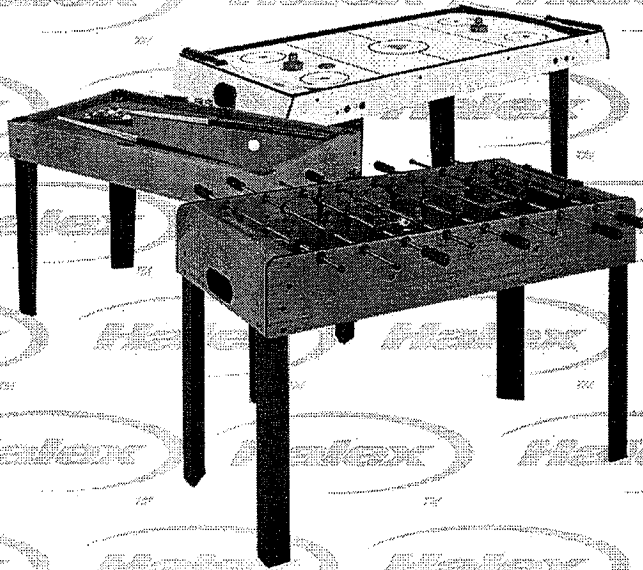



TABLE  
**Games**

*Assembly instructions*



**50705**



TM



# STATS ARCADE

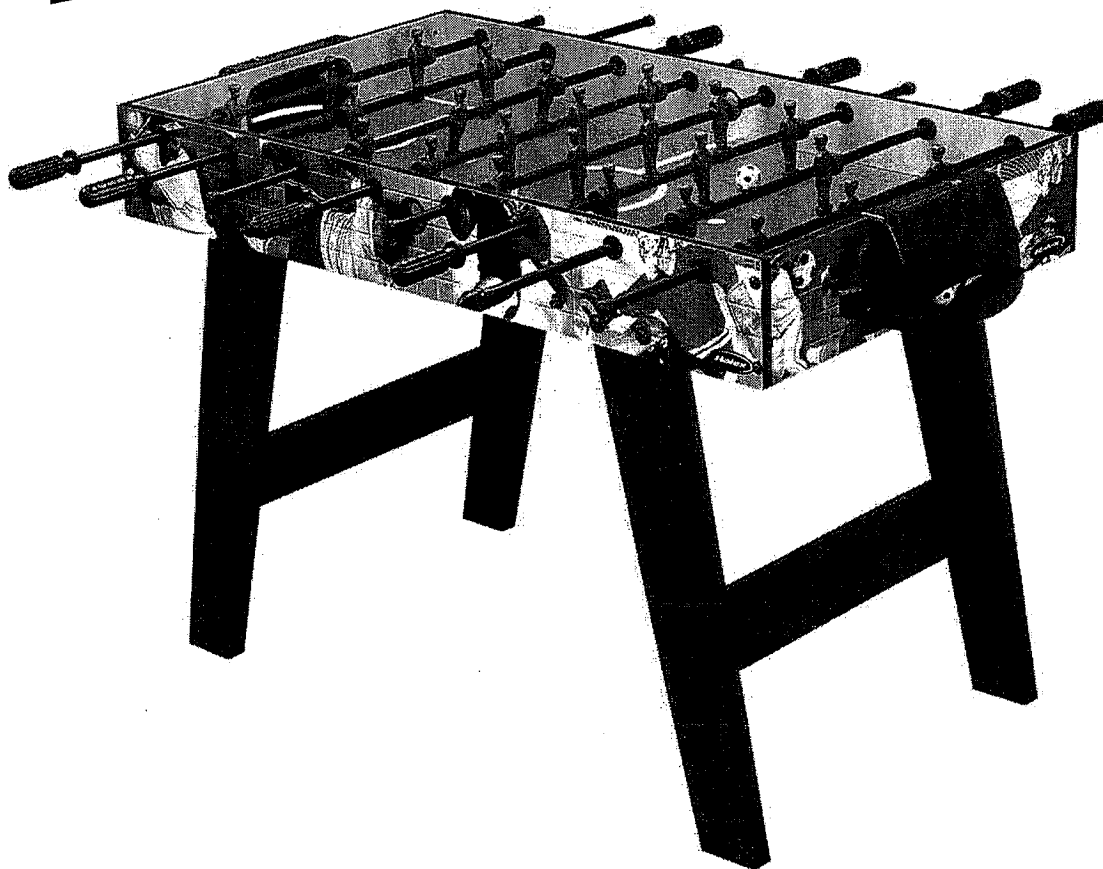

## WARNING:

**CHOKING HAZARD**—Toy contains a small ball.  
Not for children under 3 years.



ó



## ADVERTENCIA:

**PELIGRO DE ASFIXIA**—Este juguete incluye una bola pequeña. No apto para niños menores de 3 años.



ó

ó ùí ï úí eóúx  
ï xÉóúí úí xí

## **LIMITED 90 DAY WARRANTY**

This Halex product is warranted to be free from defects in workmanship or materials at the time of purchase for a period of 90 (ninety) days. Certain restrictions apply (see below).

Should any evidence of defects appear within the limited warranty period after the date of purchase, Regent Sports will either send replacement parts or advise of another course of action. A list of replaceable parts can be found on the parts order form page of this manual. Parts not listed on this order form are not replaceable. **Table tops, playing surfaces, and main frames are not replaceable.** This warranty covers normal consumer use and does not cover failures, which result from alterations, accidents, misuse, abuse, or neglect.

For prompt warranty service and special offers, please register your Halex product at our customer service center by visiting our website at: [www.regent-halex.com](http://www.regent-halex.com). Enter the following unique registration number followed by the item number of your table found on the cover of this manual: 1ZAK7 \_\_\_\_\_. You must register your product within 30 days of purchase to be eligible for warranty service. Please make sure to visit our website to order additional parts not covered under the warranty, as well as on-line instruction manuals and new product information. You may also order parts by calling our automated voice recognition system at: 877-516-9707 (Toll Free).

**A purchase receipt or other proof of date of purchase will be required before warranty service is performed.** Requests for warranty service can be provided by e-mailing the customer service department at [cstables@regent-halex.com](mailto:cstables@regent-halex.com) or by calling customer service at:

**877-516-9707 (Toll Free)**

**10:00 AM to 6:00 PM, EST. (Dec. through Jan.)**









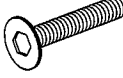

**10:00 AM to 5:00 PM, EST. (Feb. through Nov.)**

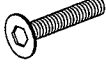
Or send request in writing to:

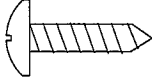

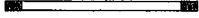
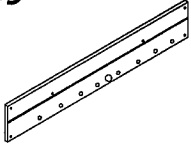
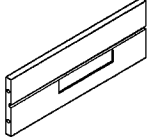
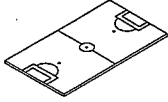
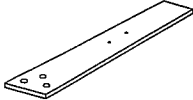
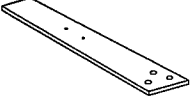
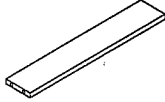
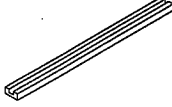
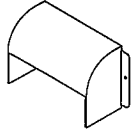
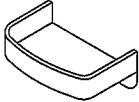



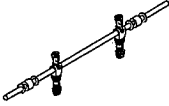
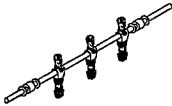
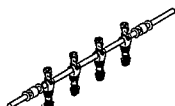

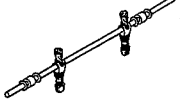
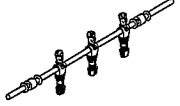
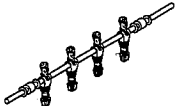

**Regent Sports Corporation**  
45 Ranick Road  
Hauppauge, NY 11788  
Attn: Halex Customer Service

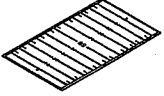
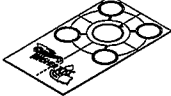
This warranty gives you specific legal rights and you may have other rights that vary from state to state.

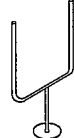
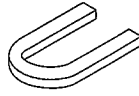
## Parts List for 50705

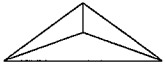
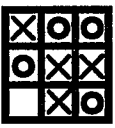
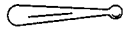
<p><b>#1</b></p>  <p>5/16" x 1-1/4" Bolt 12 pieces</p>	<p><b>#2</b></p>  <p>5/16" Washer 12 pieces</p>	<p><b>#3</b></p>  <p>1/4" x 2-1/2" Bolt 8 pieces</p>	<p><b>#4</b></p>  <p>1/4" Washer 20 pieces</p>
<p><b>#5</b></p>  <p>1/4" x 2" Bolt 8 pieces</p>	<p><b>#6</b></p>  <p>1/2" Round head screw 8 pieces</p>	<p><b>#7</b></p>  <p>1/4" Locknut 4 pieces</p>	<p><b>#8</b></p>  <p>Support rod 2 pieces</p>
<p><b>#9</b></p>  <p>Side panel 2 pieces</p>	<p><b>#10</b></p>  <p>End panel 2 pieces</p>	<p><b>#11</b></p>  <p>Playing field 1 piece</p>	<p><b>#12</b></p>  <p>Left leg 2 pieces</p>
<p><b>#13</b></p>  <p>Right leg 2 pieces</p>	<p><b>#14</b></p>  <p>End leg panel 2 pieces</p>	<p><b>#15</b></p>  <p>playfield support brace 2 pieces</p>	<p><b>#16</b></p>  <p>Goal A 2 pieces</p>
<p><b>#17</b></p>  <p>Goal B 2 pieces</p>	<p><b>#18</b></p>  <p>Handle 8 pieces</p>	<p><b>#19</b></p>  <p>Rod end cap 8 pieces</p>	<p><b>#20</b></p>  <p>Allen key 1 piece</p>
<p><b>#21</b></p>  <p>Wrench 2 pieces</p>	<p><b>#22</b></p>  <p>2-Home players rod 1 piece</p>	<p><b>#23</b></p>  <p>3-Home players rod 2 pieces</p>	<p><b>#24</b></p>  <p>4-Home players rod 1 piece</p>

## Parts List for 50705

<p><b>#25</b></p>  <p>2-Away players rod 1 piece</p>	<p><b>#26</b></p>  <p>3-Away players rod 2 pieces</p>	<p><b>#27</b></p>  <p>4-Away players rod 1 piece</p>	<p><b>#28</b></p>  <p>Soccer ball 2 pieces</p>
<p><b>#29</b></p>  <p>Game board A 1 piece</p>	<p><b>#30</b></p>  <p>Game board B 1 piece</p>	<p><b>#31</b></p>  <p>Post 2 pieces</p>	<p><b>#32</b></p>  <p>Finger football goal 1 piece</p>
<p><b>#33</b></p>  <p>Horseshoes 4 pieces</p>	<p><b>#34</b></p>  <p>Ring toss 4 pieces</p>	<p><b>#35</b></p>  <p>Finger football puck 2 pieces</p>	<p><b>#36</b></p>  <p>Tic-tac-toe 1 set</p>
<p><b>#37</b></p>  <p>Bat 2 pieces</p>	<p><b>#38</b></p>  <p>Baseball 4 pieces</p>	<p><b>#39</b></p>  <p>Paper card 6 pieces</p>	<p><b>#40</b></p>  <p>Washer toss 8 pieces</p>
<p><b>#41</b></p>  <p>Bean bag 3 pieces</p>			

**Step 1-** Insert player rods into side panel #9; follow the diagram for proper men placement. Be sure to have side panel #9 placed upside when inserting the men.

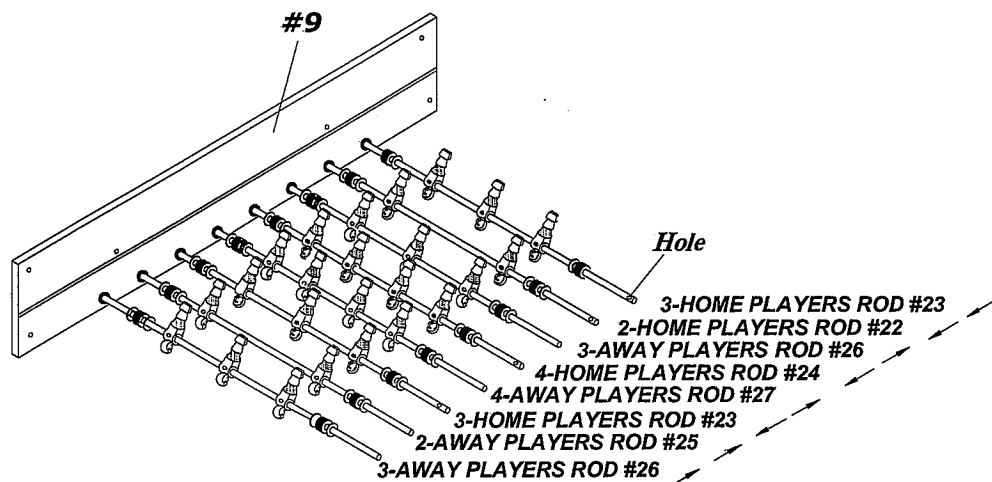

**Step 2-** Place the second side panel #9 over the other end of the rods. Next insert playing surface #11 into the grooves on the side panels.

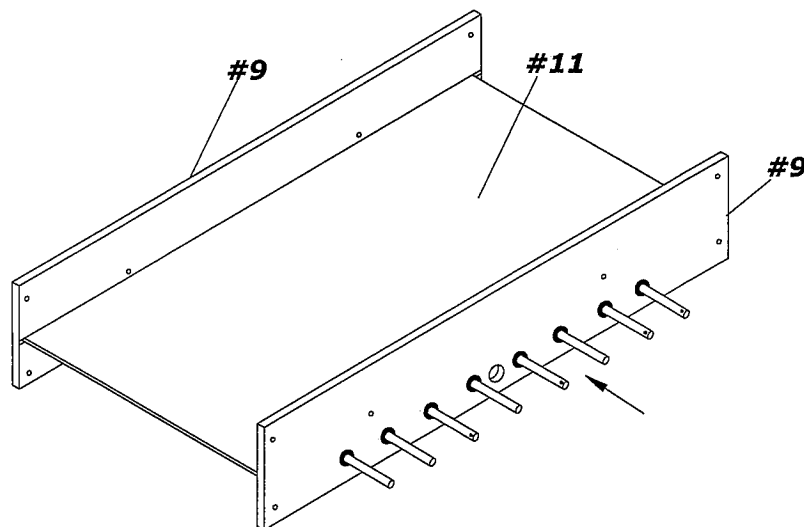

Step 3- Attach end panels #10 to each end using Washers #4 and Bolts #5. Next attach support rods #8 and braces #15 using washers #4 and nuts #7. Next attach legs #13 and #12 to the frame using Bolts #1 and washers #2. Once the legs are secure attach leg panels #14 using washers #4 and bolts #3.

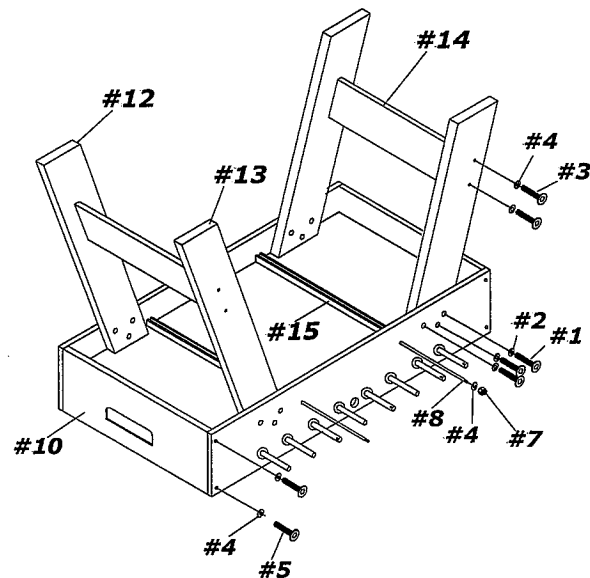

Step 4- With the assistance of another adult flip the table over to its standing position. Next attach goals #16 & #17 using screws #6. Next attach handles #18 and end caps #19 to the player rods. Be sure to follow the diagram for proper placement.

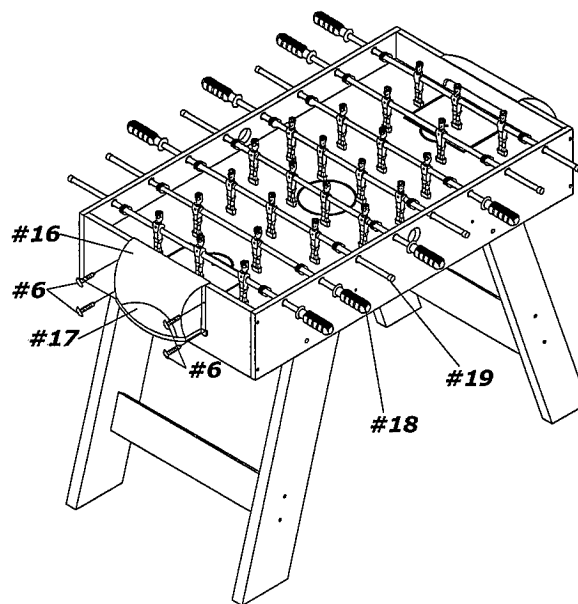

Step 5- Place boards on top of the soccer base assembly when playing additional games.

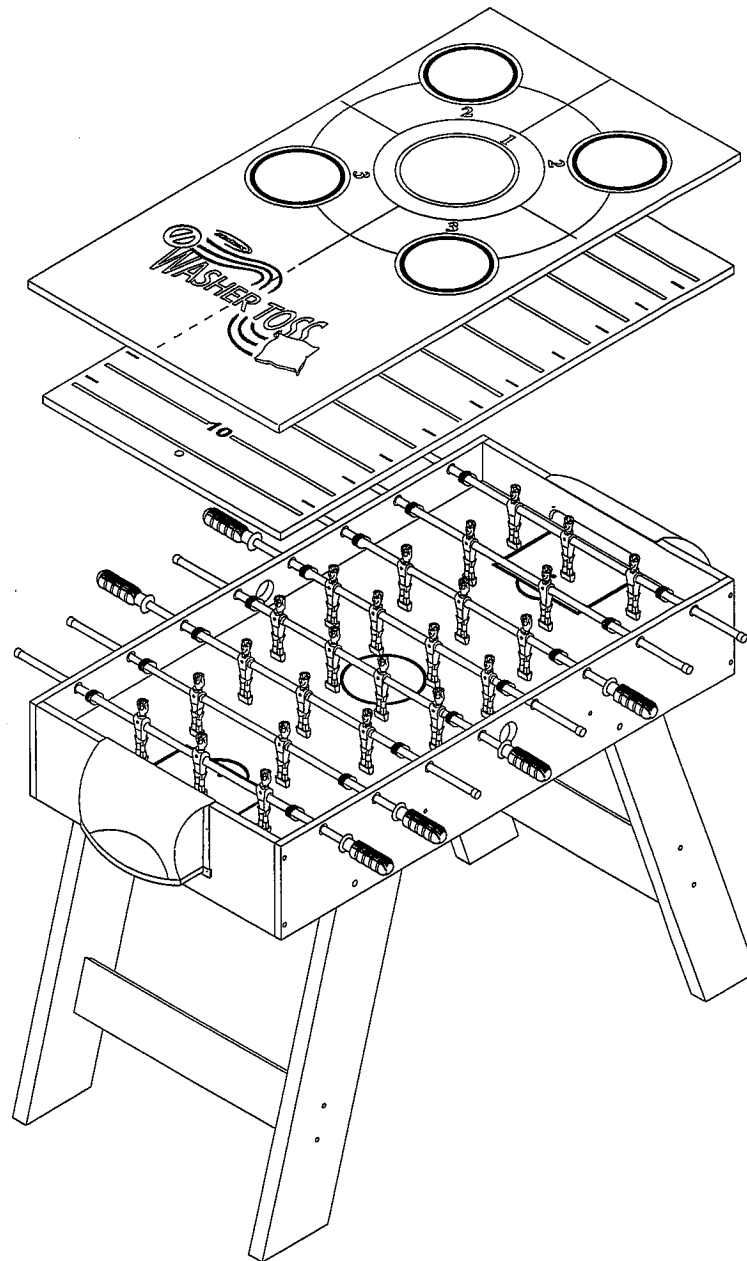

# 50705

## PARTS ORDER FORM

If for some reason you are missing any assembly parts for your Halex game table, please call the Regent Sports Customer Service line at 1-877 516-9707 (toll free) between the hours of 10:00am and 5:00 pm EST or go online at [www.regent-halex.com](http://www.regent-halex.com) for parts ordering. Please refer to the REGENT SPORTS LIMITED WARRANTY concerning missing and defective parts.

Parts also may be ordered by filling out the form below. Please fill in all the information and return to:

REGENT SPORTS CORP.  
45 RANICK ROAD  
HAUPPAUGE, NEW YORK, 11788  
ATTN: CUSTOMER SERVICE

REGENT SPORTS CORP. requires that check, money order, VISA, or MC must pay all orders for replacement parts. Cash is not accepted. Please make all checks or money orders payable to REGENT SPORTS CORP. *Please note all prices include shipping and handling.*

Name of Purchaser: \_\_\_\_\_  
Address: \_\_\_\_\_  
City: \_\_\_\_\_  
State: \_\_\_\_\_ Zip Code: \_\_\_\_\_  
Phone: \_\_\_\_\_

PART #	DESCRIPTION	QUANTITY	PRICE	TOTAL COST
197-50705-01	5/16" x 1 1/4" Bolt	12	\$1.50 ea	
197-50705-02	5/16" Washer	12	\$1.50 ea	
197-50705-03	1/4" x 2 1/2" Bolt	8	\$1.50 ea	
197-50705-04	1/4" Washer	20	\$1.50 ea	
197-50705-05	1/4" x 2" Bolt	8	\$1.50 ea	
197-50705-06	1/2" Round Head Screw	8	\$1.50 ea	
197-50705-07	1/4" Locknut	4	\$1.50 ea	
197-50705-08	Support Rod	2	\$10.00 ea	
197-50705-09	Side Panel	2	\$12.50ea	
197-50705-10	End Panel	2	\$12.50ea	
197-50705-11	Playing Field	1	\$15.00ea	
197-50705-12	Left Leg	2	\$12.50ea	
197-50705-13	Right Leg	2	\$12.50ea	
197-50705-14	End Leg Panel	2	\$10.00ea	
197-50705-15	Playfield Support Brace	2	\$9.50 ea	
197-50705-16	Goal "A"	2	\$8.50 ea	
197-50705-17	Goal "B"	2	\$8.50 ea	
197-50705-18	Handle	8	\$3.00 ea	
197-50705-19	Rod End Cap	8	\$1.50 ea	
197-50705-20	Allen Key	1	\$1.50 ea	
197-50705-21	Wrench	2	\$1.50 ea	
197-50705-22	2-Home Player Rod	1	\$14.60 ea	
197-50705-23	3-Home Player Rod	2	\$15.00 ea	
197-50705-24	4-Home Player Rod	1	\$15.00 ea	
197-50705-25	2-Away Player Rod	1	\$14.50 ea	
197-50705-26	3-Away Player Rod	2	\$15.00 ea	
197-50705-27	4-Away Player Rod	1	\$15.00 ea	
197-50705-28	Soccer Ball	2	\$3.00 ea	

# 50705

197-50705-29	Game Board "A"	1	\$15.00 ea	
197-50705-30	Game Board "B"	1	\$15.00 ea	
197-50705-31	Post	2	\$3.00 ea	
197-50705-32	Finger Football Goal	1	\$3.15 ea	
197-50705-33	Horseshoe	4	\$4.30 ea	
197-50705-34	Ring Toss	4	\$3.00 ea	
197-50705-35	Finger Football Puck	2	\$3.00 ea	
197-50705-36	Tic-Tac-Toe	1 set	\$4.50 set	
197-50705-37	Bat	2	\$3.00 ea	
197-50705-38	Baseball	4	\$2.00 ea	
197-50705-39	Paper Card	6	\$2.00 ea	
197-50705-40	Washer Toss	8	\$2.00 ea	
197-50705-41	Bean Bag	3	\$4.00 ea	

**\*\*PRICES SUBJECT TO CHANGE WITHOUT NOTICE.**

# Game Rules

## Foosball Table Game Rules

### To Start a Match:

- A coin flip shall precede the start of the match. The team that wins the flip has the choice of table side or first serve.

### The Serve:

- A serve through the serving hole is used to put the ball into play at the start of the match, after a point is scored, or after a ball leaves the table.

### Subsequent Serves:

- Following the first serve of the match, subsequent serves shall be made by the team last scored upon.

### Ball in Play:

- Once a ball is put in play by the server, it shall remain in play until the ball is hit off the table, a dead ball is declared, time out is called, or a point is scored.

### Ball Off the Table:

- The ball should be put back into play with a serve by the team which originally served that ball.

### Dead Ball:

- A ball shall be declared dead when it has completely stopped its motion and is not within reach of any player figure.
- If the ball is declared dead between the goalie and the 2-man rods, it shall be put back into play by placing the ball in the corner nearest the spot of the dead ball.
- If the ball is declared dead anywhere else on the table, it shall be put back into play with a serve by the team that originally served that ball.

### Point Scored:

- A ball entering the goal shall count as a point, as long as it was legally scored. A ball which enters the goal but returns to the playing surface and/or leaves the table still counts as a goal.

### Change of Positions:

- In any doubles event, each player may play only the two rods normally designated for his position. Once the ball is put into play, the players must play the same position until a point is scored.

### Spinning the Rods:

- Spinning the rods is illegal. Spinning is defined as the rotation of any soccer figure more than 360 degrees before or after striking the ball.
- If the ball goes in the goal, then it will not be counted as a point and will be put back into play by the goalie as if the ball had been declared a dead ball between the goal and the nearest two-man rod.

### Jarring:

- Any jarring, sliding, or lifting of the table shall be illegal.

### Reaching Into The Playing Area:

- It is illegal for a player to reach into the playing area while the ball is in play.

## Finger Flick Football

- 1) Place goal post into hole at end of playing field.
- 2) Flip a coin to determine first possession.
- 3) Player begins by placing football flat on their own 20 yard line, then sliding the ball toward the opponent's goal.

- 4) The player has 4 downs to score a touchdown by successfully sliding the football into the opponent's end zone. If any portion of the ball comes to rest past the goal line, then a touchdown has been scored for 6 points. The extra point attempt is tried from the halfway point between midfield and the opponent's goal line.
- 5) On player's 4<sup>th</sup> down, he may decide to attempt a field goal, worth 3 points, if he does not like his chances of scoring a touchdown.
- 6) If the player fails to score a touchdown or field goal during their possession, then his opponent assumes possession from the spot of the ball where it came to rest after the 4<sup>th</sup> down.
- 7) If ball goes out of bounds, then the opponent takes possession of the ball from the point where it left the playing field.
- 8) The game can either be determined by time or by the 1<sup>st</sup> player to score 21 points.

### **Baseball**

The game of Baseball is like the real game of baseball, nine innings. Each team gets a chance to bat. The player takes the wood bat and a 1 baseball. Place the baseball on the home plate. Flick the bat and hit the baseball. Try to hit the baseball to a part of the field where it will land on a circle. If the ball lands on any part of the circle, you do what the circle says. Place that ball that was just hit on the base that it tells you to go on. ( example. If it lands on circle that says second base, place that baseball on the second base). If the ball is hit, and it doesn't land on a circle, then it is an out. The player then places another baseball on the plate and flicks the bat. The player keeps doing this until he get 3 outs. 3 outs and the inning is over. Then next team bats.

### **Tic Tac Toe**

The object of the game Tic Tac Toe is to get three in a row (horizontally, diagonally or vertically). There are two players; one known as X and the second is O. Players alternate turns placing Xs and Os on the game board until either opponent has three in a row or the board is filled. X always goes first, to choose which player is X a simple coin toss can be used or an agreement between each of the players can be established before the start of the game.

**Please note that your game may not include all the games listed. These are general rules for all of our different game tables.**

# STATS ARCADE



AAA BY AIRCRAFT

0  
0  
0

0  
0

**Also be sure to check out our web site at:**

**[www.regent-halex.com](http://www.regent-halex.com)**

• Parts Ordering • Owners Manual • Product Information



© 2007  
Regent Sports Corporation  
Hauppauge, New York