

Halex

Halex

Halex

Ha

lex

Halex

Halex

Halex

TABLE

# Games

Assembly instructions

lex

Halex

Halex

Halex

Halex

Halex

Ha

lex

Halex

Halex

Halex

Halex

Ha

lex

Halex

Halex

Halex

Halex

Halex

Halex

Ha

lex

Halex

Halex

Halex



50672

**PLEASE DO NOT RETURN THIS ITEM TO THE STORE!**

**Should you have a defect or parts issue, please refer to the warranty instructions listed below and contact Regent Sports at our toll free number!!**

**LIMITED 90 DAY WARRANTY**

This Halex product is warranted to be free from defects in workmanship or materials at the time of purchase for a period of 90 (ninety) days. Certain restrictions apply (see below).

Should any evidence of defects appear within the limited warranty period after the date of purchase, Regent Sports will either send replacement parts or advise of another course of action. A list of replaceable parts can be found on the parts order form page of this manual. Parts not listed on this order form are not replaceable. **Table tops, playing surfaces, and main frames are not replaceable.** This warranty covers normal consumer use and does not cover failures, which result from alterations, accidents, misuse, abuse, or neglect.

For prompt warranty service and special offers, please register your Halex product at our customer service center by visiting our website at: [www.regent-halex.com](http://www.regent-halex.com). Enter the following unique registration number followed by the item number of your table found on the cover of this manual: 1ZAK7 \_\_\_\_\_. You must register your product within 30 days of purchase to be eligible for warranty service. Please make sure to visit our website to order additional parts not covered under the warranty, as well as on-line instruction manuals and new product information. You may also order parts by calling our automated voice recognition system (877) 516-8707.

**A purchase receipt or other proof of date of purchase will be required before warranty service is performed.** Requests for warranty service can be provided by e-mailing the customer service department at [cstables@regent-halex.com](mailto:cstables@regent-halex.com) or by calling customer service at:

**877-516-9707 (Toll Free)**

**10:00 AM to 6:00 PM, EST. (Dec. through Jan.)**











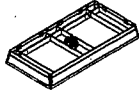
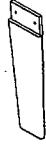
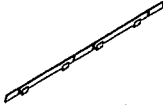



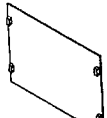



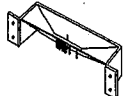



**10:00 AM to 5:00 PM, EST. (Feb. through Nov.)**

Or send request in writing to:

**Regent Sports Corporation**  
45 Ranick Road  
Hauppauge, NY 11788  
Attn: Halex Customer Service

This warranty gives you specific legal rights and you may have other rights that vary from state to state.

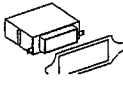
# AIR HOCKEY 50672 PARTS LIST

<p>① PRE-INSTALLED</p>  <p>TABLE ASSEMBLY 1EA</p>	<p>② 197-50672-02</p>  <p>LEG 4EA</p>	<p>③ 197-50672-03</p>  <p>SIDE APRON-BOTTOM 2EA</p>	<p>④ 197-50672-04</p>  <p>END APRON-BOTTOM 2EA</p>	<p>⑤ 197-50672-05</p>  <p>3.5X14MM WASHER HEAD SCREW 26EA</p>	<p>⑥ 197-50672-06</p>  <p>8X35MM LEG BOLT 8EA</p>
<p>⑦ 197-50672-07</p>  <p>22MM FLAT WASHER 8EA</p>	<p>⑧ 197-50672-08</p>  <p>LEG END PANEL 4EA</p>	<p>⑨ 197-50672-09</p>  <p>3.5X33MM FLAT HEAD SCREW 20EA</p>	<p>⑩ 197-50672-10</p>  <p>4X10MM WASHER HEAD BOLT 8EA</p>	<p>⑪ 197-50672-11</p>  <p>LEG LEVELER 4EA</p>	<p>⑫ 197-50672-12 PRE-INSTALLED</p>  <p>HOCKEY MOTOR 1EA</p>
<p>⑬ 197-50672-13 PRE-INSTALLED</p>  <p>INDUCTANCE BOX 2EA</p>	<p>⑭ 197-50672-14</p>  <p>BALL RETURN TRAY 2EA</p>	<p>⑮ 197-50672-15</p>  <p>ALLEN KEY 1EA</p>	<p>⑯ 197-50672-16</p>  <p>PUSHER 2EA</p>	<p>⑰ 197-50672-17</p>  <p>PUCK 4EA</p>	<p>⑱ 197-50672-18</p>  <p>APRON CORNER 4EA</p>
<p>⑲ 197-50672-19</p>  <p>3.5X12MM WASHER HEAD SCREW 12EA</p>	<p>⑳ 197-50672-20</p>  <p>SCORER HOLDER 2EA</p>	<p>㉑ 197-50672-21</p>  <p>FIXER 2EA</p>	<p>㉒ 197-50672-22</p>  <p>SCORER 1EA</p>	<p>㉓ 197-50672-23</p>  <p>4X18MM WASHER HEAD BOLT 12EA</p>	<p>㉔ 197-50672-24</p>  <p>SLIDE SCORER 2EA</p>
<p>㉕ 197-50672-25</p>  <p>CONTROL BOX 1EA</p>	<p>㉖ 197-50672-26</p>  <p>PLASTIC STOPPER 2EA</p>				

Step 1 -

Attach the Side Apron #3 to the Table Assembly #1 using Washer Head Screw #5. Next attach the End Apron #4 to the Table Assembly #1 using Washer Head Screw #5. Next attach the Apron Corner #18 to the Side Apron #3 and End Apron #4 using Washer Head Screw #19. Repeat steps for all four corners.

**FIG1**

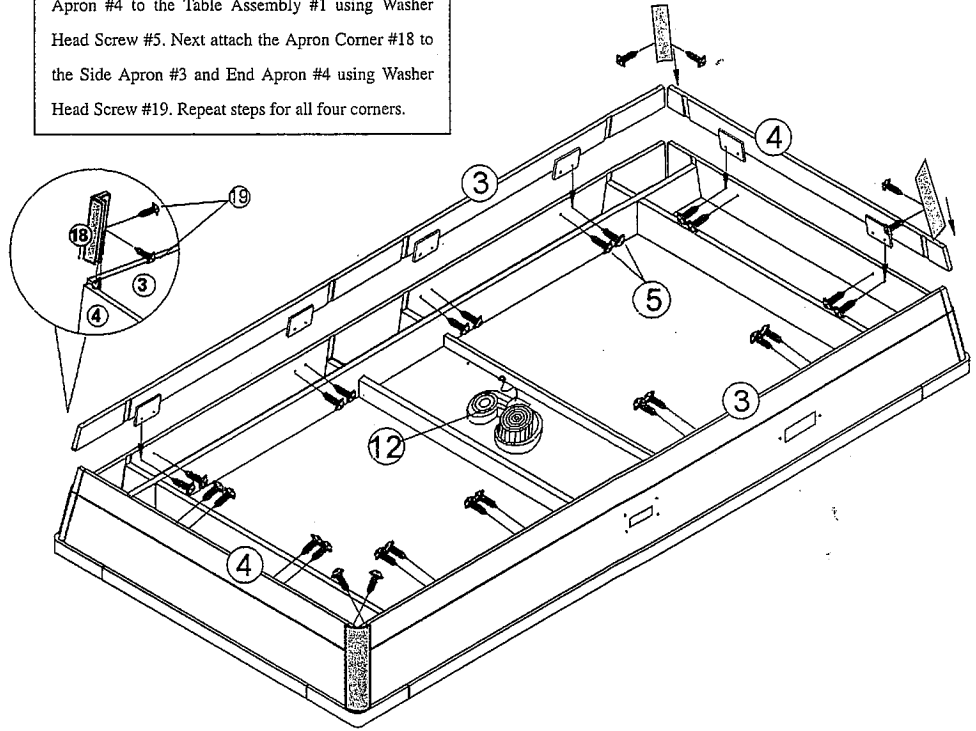

**FIG2**

Step 2 -

First assemble the legs by attaching the Leg End Panel #8 to the Leg #2 using Flat Head Screw #9. Repeat steps to both sides of the legs. Next attach Legs #2 and Leg End Panels #8 to the Table Assembly #1 using Leg Bolt #6 and Flat Washer #7. Next screw in the Leg Leveler #11 to each Leg #2. Next attach Ball Return Tray #14 to the Table Assembly #1 using Washer Head Screw #19.

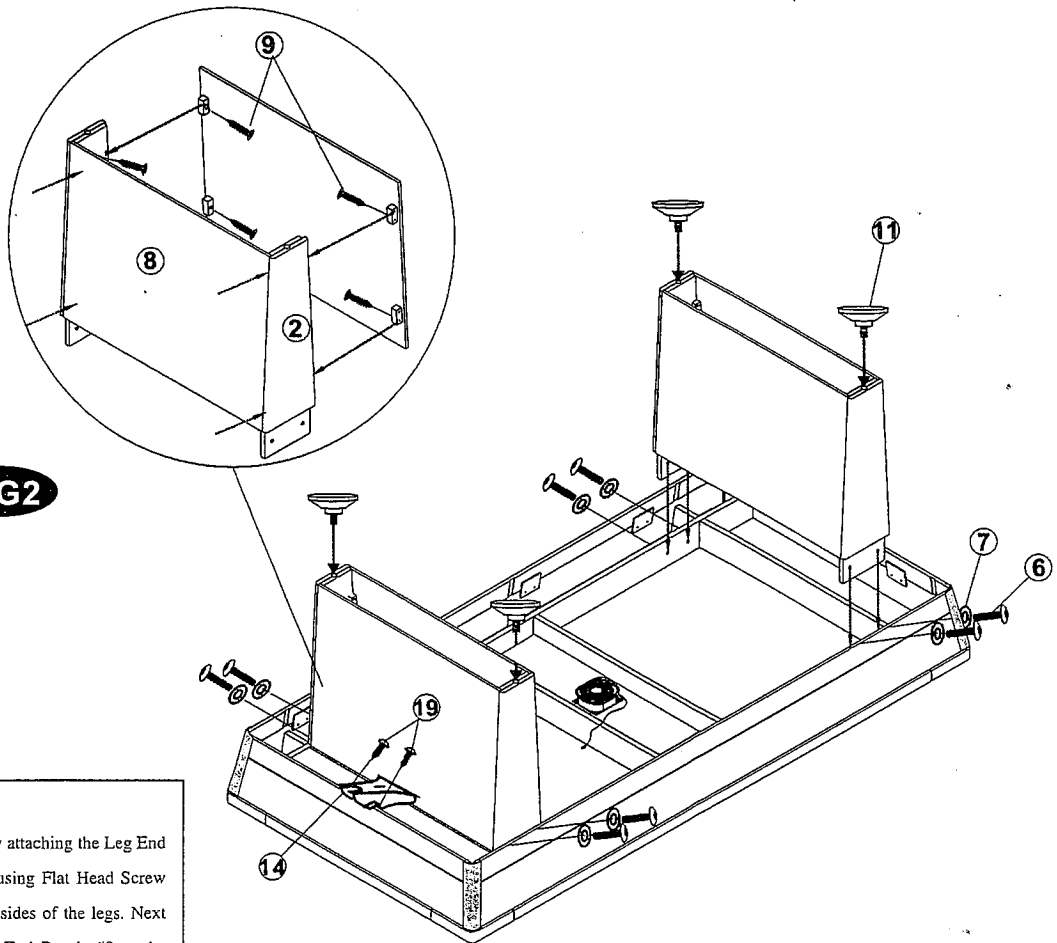
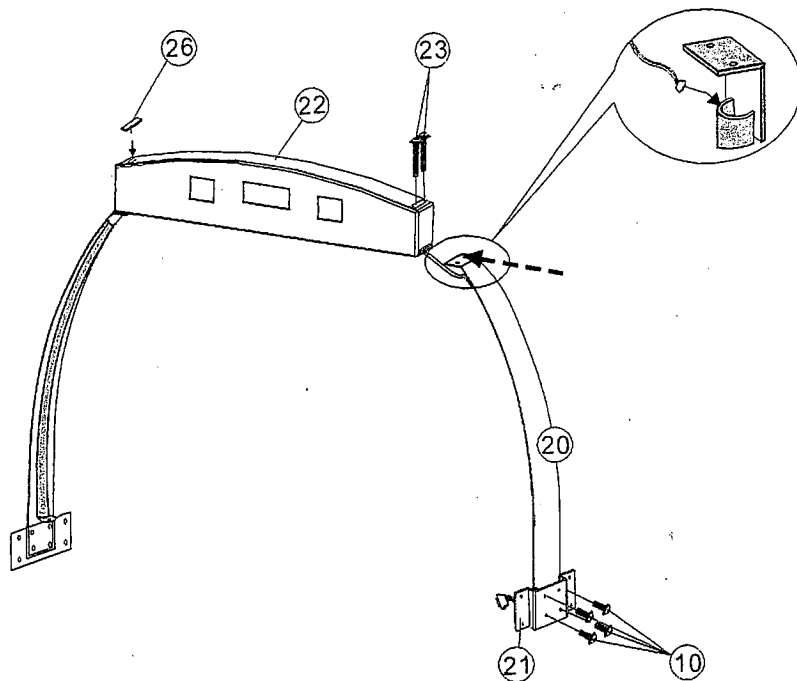

**FIG4**

Step 3 -

Scoring Unit Assembly:

Attach Scorer #22 to the Scorer Holder #20 using Washer Head Bolt #23. Place the Plastic Stopper #26 on the Scorer #22. Next attach the Fixer #21 to the Scorer Holder #20 using Washer Head Bolt #10.



**FIG4**

Step 4 -

With the help of two adults, carefully place the table face up on a flat surface. Attach Scorer #22 to the table using Washer Head Bolt #23 and Washer Head Screw #5. Next attach Slide Scorer #24 to the side panel using Flat Head Screw #9. Follow the diagram below and attach Control Box #25 to the table. Enjoy the

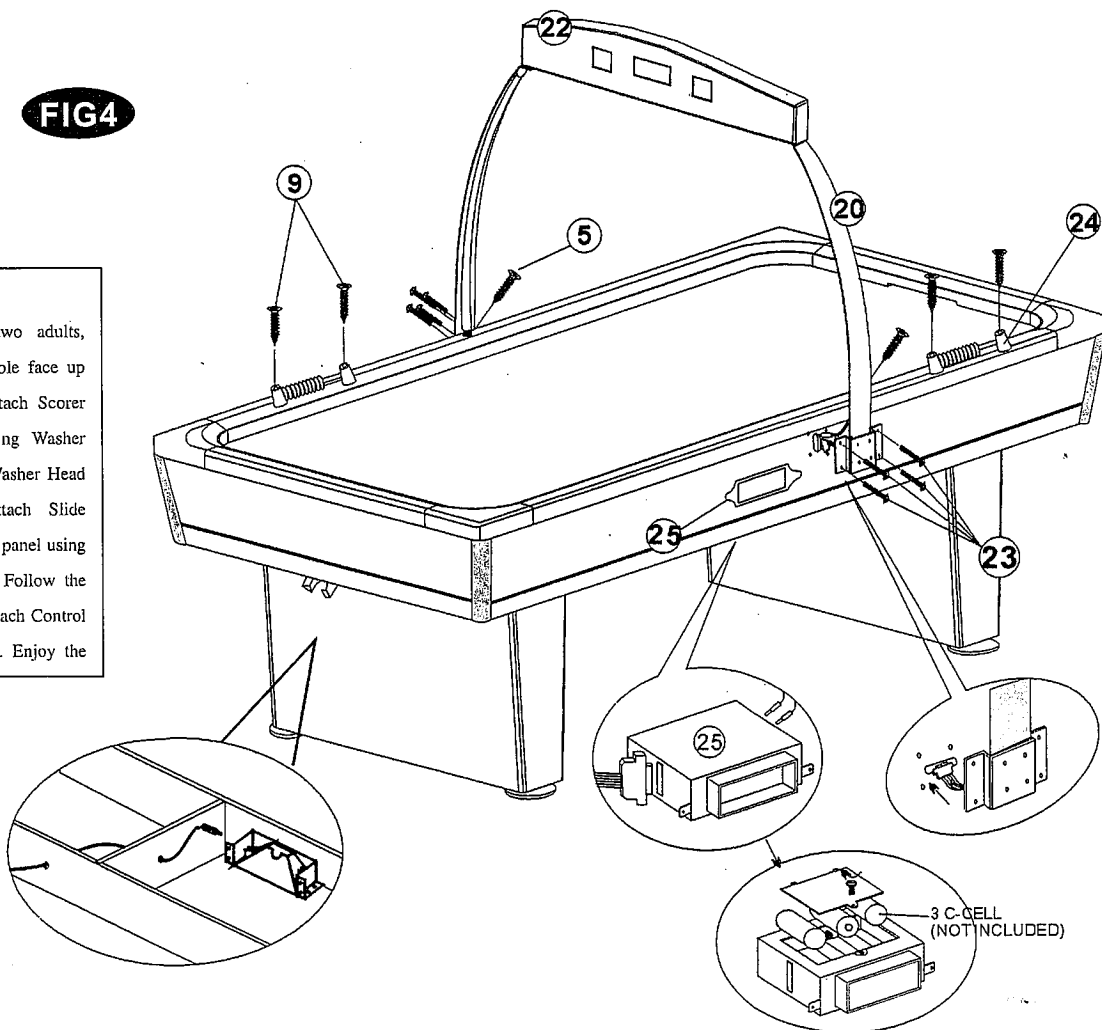

## PARTS ORDER FORM

Part #	Description	Quantity	Price	Total Cost
197-50672-02	Leg	4	\$12.50 ea	
197-50672-03	Bottom Side Apron	2	\$15.00 ea	
197-50672-04	Bottom End Apron	2	\$12.00 ea	
197-50672-05	3.5 X 14MM Washer Head Screw	26	\$1.25 ea	
197-50672-06	8 X 35MM Leg Bolt	8	\$1.25 ea	
197-50672-07	22MM Flat Washer	8	\$1.25 ea	
197-50672-08	Leg End Panel	4	\$15.00 ea	
197-50672-09	3.5 X 33MM Flat Head Screw	20	\$1.25 ea	
197-50672-10	4 X 10MM Washer Head Bolt	8	\$1.25 ea	
197-50672-11	Leg Leveler	4	\$5.00 ea	
197-50672-12	Hockey Motor	1	\$15.00 ea	
197-50672-13	Inductance Box	2	\$5.00 ea	
197-50672-14	Ball Return Tray	2	\$5.00 ea	
197-50672-15	Allen Key	1	\$1.25 ea	
197-50672-16	Pusher	2	\$4.00 ea	
197-50672-17	Puck	4	\$2.00 ea	
197-50672-18	Apron Corner	4	\$5.00 ea	
197-50672-19	3.5 X 12MM Washer Head Screw	12	\$1.25 ea	
197-50672-20	Scorer Holder	2	\$5.00 ea	
197-50672-21	Bracket	2	\$3.00 ea	
197-50672-22	Electronic Scorer	1	\$15.00 ea	
197-50672-23	4 X 18MM Washer Head Bolt	12	\$1.25 ea	
197-50672-24	Slide Scorer	2	\$5.00 ea	
197-50672-25	Control Box	1	\$5.00 ea	
197-50672-26	Plastic Stopper	2	\$2.00 ea	

**Also be sure to check out our web site at:**

**[www.regent-halex.com](http://www.regent-halex.com)**

• **Parts Ordering** • **Owners Manual** • **Product Information**



© 2007  
Regent Sports Corporation  
Hauppauge, New York