

TABLE

# Games

*Assembly instructions*

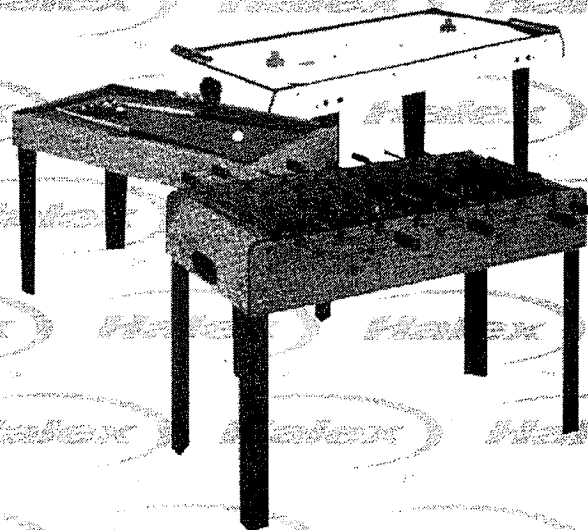

50626

**Halex**

TM

**PLEASE DO NOT RETURN THIS ITEM TO THE STORE!**

**Should you have a defect or parts issue, please refer to the warranty instructions listed below and contact Regent Sports at our toll free number!!**

**LIMITED 90 DAY WARRANTY**

This Halex product is warranted to be free from defects in workmanship or materials at the time of purchase for a period of 90 (ninety) days. Certain restrictions apply (see below).

Should any evidence of defects appear within the limited warranty period after the date of purchase, Regent Sports will either send replacement parts or advise of another course of action. A list of replaceable parts can be found on the parts order form page of this manual. Parts not listed on this order form are not replaceable. **Table tops, playing surfaces, and main frames are not replaceable.** This warranty covers normal consumer use and does not cover failures, which result from alterations, accidents, misuse, abuse, or neglect.

For prompt warranty service and special offers, please register your Halex product at our customer service center by visiting our website at: [www.regent-halex.com](http://www.regent-halex.com). Enter the following unique registration number followed by the item number of your table found on the cover of this manual: 1ZAK7 \_\_\_\_\_. You must register your product within 30 days of purchase to be eligible for warranty service. Please make sure to visit our website to order additional parts not covered under the warranty, as well as on-line instruction manuals and new product information. You may also order parts by calling our automated voice recognition system (877) 516-8707.

**A purchase receipt or other proof of date of purchase will be required before warranty service is performed.** Requests for warranty service can be provided by e-mailing the customer service department at [cstables@regent-halex.com](mailto:cstables@regent-halex.com) or by calling customer service at:

**877-516-9707 (Toll Free)**

**10:00 AM to 6:00 PM, EST. (Dec. through Jan.)**











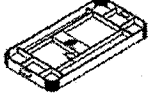



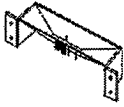
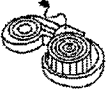

**10:00 AM to 5:00 PM, EST. (Feb. through Nov.)**

Or send request in writing to:

**Regent Sports Corporation**  
45 Ranick Road  
Hauppauge, NY 11788  
Attn: Halex Customer Service

This warranty gives you specific legal rights and you may have other rights that vary from state to state.

# AIR HOCKEY 50625/50626 PARTS LIST

<p>① 197-50626-01</p>  <p>TABLE ASSEMBLY 1EA</p>	<p>② 197-50626-02</p>  <p>LEG 4EA</p>	<p>③ 197-50626-03</p>  <p>LEG PANEL 4EA</p>	<p>④ 197-50626-04</p>  <p>4X18MM WASHER HEAD BOLT 24EA</p>	<p>⑤ 197-50626-05</p>  <p>22MM FLAT WASHER 8EA</p>	<p>⑥ 197-50626-06</p>  <p>8X40MM ALLEN KEY LEG BOLT 8EA</p>
<p>⑦ 197-50626-07</p>  <p>PUCK RETURN UNIT 2EA</p>	<p>⑧ 197-50626-08 PRE-INSTALLED</p>  <p>INDUCTIVE BOX 2EA</p>	<p>⑨ 197-50626-09 PRE-INSTALLED</p>  <p>HOCKEY MOTOR 1EA</p>	<p>⑩ 197-50626-10</p>  <p>3.5X12MM WASHER HEAD SCREW 4EA</p>	<p>⑪ 197-50626-11</p>  <p>PUSHER 2EA</p>	<p>⑫ 197-50626-12</p>  <p>PUCK-RED 2EA</p>
<p>⑬ 197-50626-13</p>  <p>LCD SCORER 1EA</p>	<p>⑭ 197-50626-14</p>  <p>LEVELER 4 EA</p>	<p>⑮ 197-50626-15</p>  <p>SLIDE SCORER 2EA</p>	<p>⑯ 197-50626-16</p>  <p>3.5X25MM FLAT HEAD SCREW 4EA</p>	<p>⑰ 197-50626-17</p>  <p>3.5X14MM FLAT HEAD SCREW 2EA</p>	<p>⑱ 197-50626-18</p>  <p>PUCK-YELLOW 2EA</p>
<p>⑲ 197-50626-12</p>  <p>ALLEN KEY 1EA</p>					

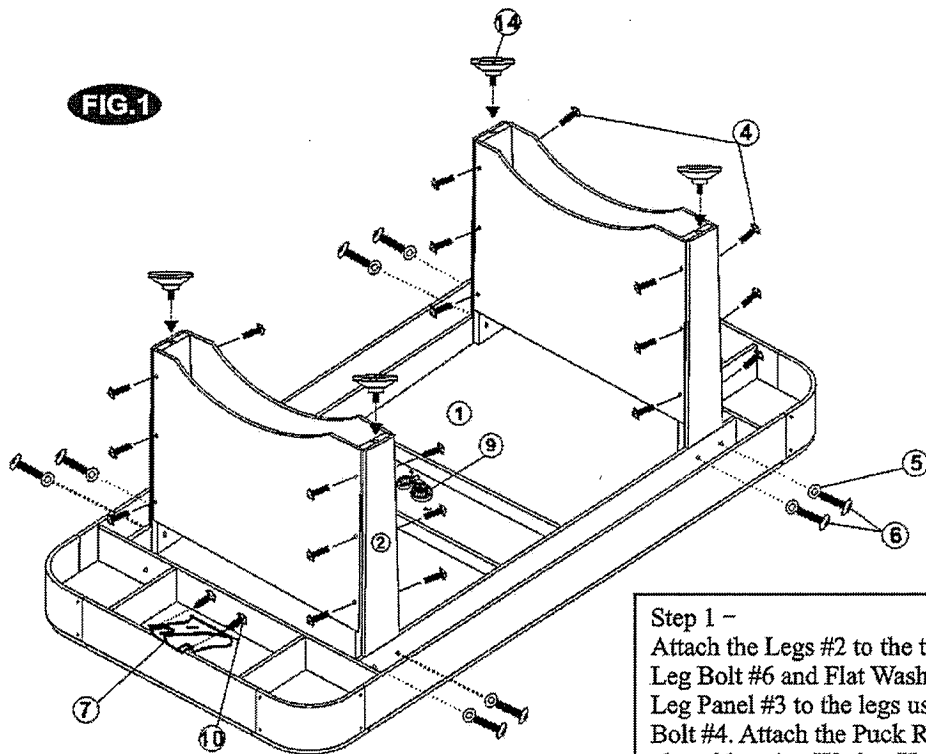

**FIG. 1**

Step 1 -  
 Attach the Legs #2 to the table assembly using Leg Bolt #6 and Flat Washer #5. Next attach the Leg Panel #3 to the legs using Washer Head Bolt #4. Attach the Puck Return Unit #7 to the table using Washer Head Screw #10. Next screw in Leg Levelers #14.

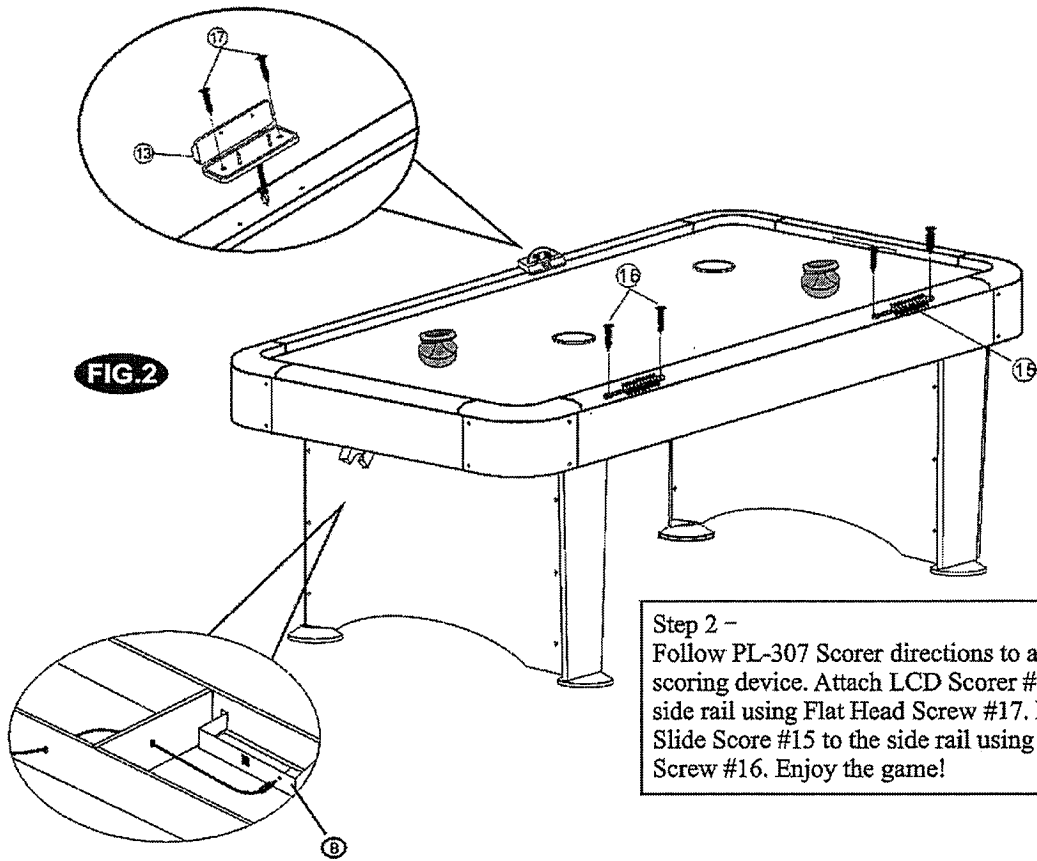

**FIG. 2**

Step 2 -  
 Follow PL-307 Scorer directions to assemble the scoring device. Attach LCD Scorer #13 to the side rail using Flat Head Screw #17. Next attach Slide Score #15 to the side rail using Flat Head Screw #16. Enjoy the game!

# PL-307 SCORER

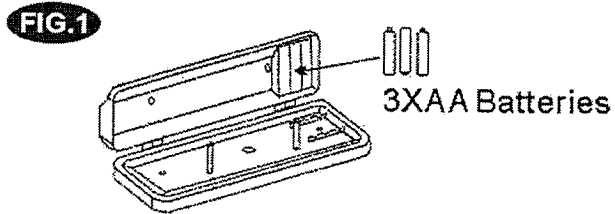

FIG.1: Insert 3 AA Batteries to the correct place.

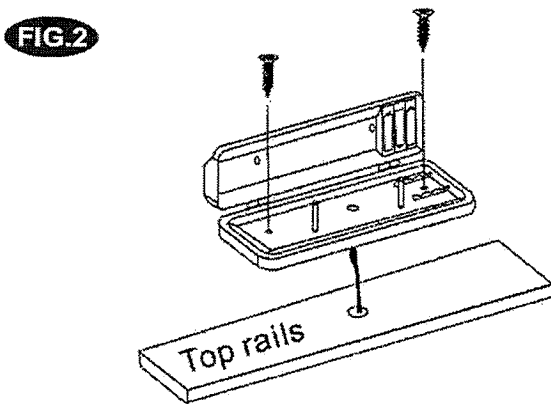

FIG.2: Attach the Scorer to the table top rails using two Screws.



## PARTS ORDER FORM

Part #	Description	Quantity	Price	Total Cost
197-50626-02	Leg	4	\$14.00 ea	
197-50626-03	Leg Panel	4	\$15.00 ea	
197-50626-04	4 X 18 MM Washer Head Bolt	24	\$1.25 ea	
197-50626-05	22 MM Flat Washer	8	\$1.25 ea	
197-50626-06	8 X 40 MM Allen Key Leg Bolt	8	\$1.25 ea	
197-50626-07	Puck Return Unit	2	\$5.00 ea	
197-50626-08	Inductive Box	2	\$5.00 ea	
197-50626-09	Hockey Motor	1	\$10.00 ea	
197-50626-10	3.5 X 12 MM Washer Head Screw	4	\$1.25 ea	
197-50626-11	Pusher	2	\$4.00 ea	
197-50626-12	Red Puck	2	\$2.00 ea	
197-50626-13	LCD Scorer	1	\$15.00 ea	
197-50626-14	Leg Leveler	4	\$6.00 ea	
197-50626-15	Slide Scorer	2	\$5.00 ea	
197-50626-16	3.5 X 25 MM Flat Head Screw	4	\$1.25 ea	
197-50626-17	3.5 X 14 MM Flat Head Screw	24	\$1.25 ea	
197-50626-18	Yellow Puck	2	\$2.00 ea	
197-50626-19	Allen Key	1	\$1.25 ea	

Also be sure to check out our web site at:

**[www.regent-halex.com](http://www.regent-halex.com)**

• Parts Ordering • Owners Manual • Product Information



© 2007  
Regent Sports Corporation  
Hauppauge, New York