

TABLE

Games

Assembly instructions

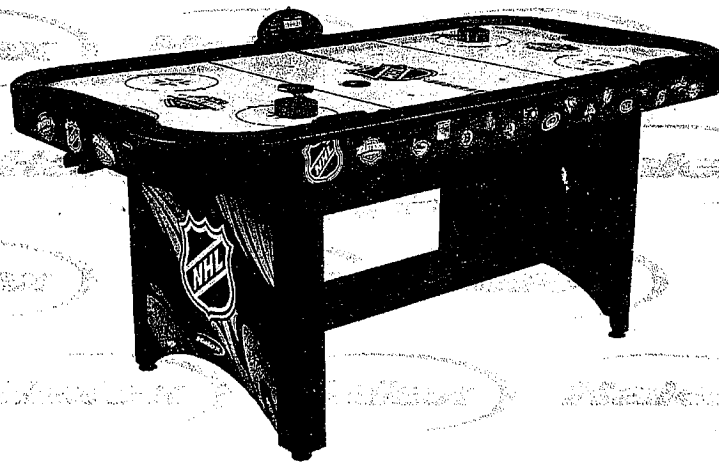

50611

Halex
TM

PLEASE DO NOT RETURN THIS ITEM TO THE STORE!

Should you have a defect or parts issue, please refer to the warranty instructions listed below and contact Regent Sports at our toll free number!!

LIMITED 90 DAY WARRANTY

This Halex product is warranted to be free from defects in workmanship or materials at the time of purchase for a period of 90 (ninety) days. Certain restrictions apply (see below).

Should any evidence of defects appear within the limited warranty period after the date of purchase, Regent Sports will either send replacement parts or advise of another course of action. A list of replaceable parts can be found on the parts order form page of this manual. Parts not listed on this order form are not replaceable. **Table tops, playing surfaces, and main frames are not replaceable.** This warranty covers normal consumer use and does not cover failures, which result from alterations, accidents, misuse, abuse, or neglect.

For prompt warranty service and special offers, please register your Halex product at our customer service center by visiting our website at: www.regent-halex.com. Enter the following unique registration number followed by the item number of your table found on the cover of this manual: 1ZAK7 _____. You must register your product within 30 days of purchase to be eligible for warranty service. Please make sure to visit our website to order additional parts not covered under the warranty, as well as on-line instruction manuals and new product information. You may also order parts by calling our automated voice recognition system (877) 516-8707.

A purchase receipt or other proof of date of purchase will be required before warranty service is performed. Requests for warranty service can be provided by e-mailing the customer service department at cstables@regent-halex.com or by calling customer service at:

877-516-9707 (Toll Free)

10:00 AM to 6:00 PM, EST. (Dec. through Jan.)











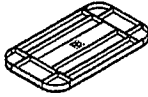









10:00 AM to 5:00 PM, EST. (Feb. through Nov.)

Or send request in writing to:

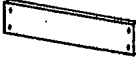
Regent Sports Corporation
45 Ranick Road
Hauppauge, NY 11788
Attn: Halex Customer Service

This warranty gives you specific legal rights and you may have other rights that vary from state to state.

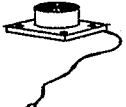
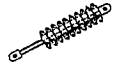
AIR HOCKEY 50611 PARTS LIST

<p>① (197-50611-01)</p>  <p>TABLE ASSEMBLY 1EA</p>	<p>② (197-50611-02)</p>  <p>RIGHT LEG 2EA</p>	<p>③ (197-50611-03)</p>  <p>LEFT LEG 2EA</p>	<p>④ (197-50611-04)</p>  <p>LEG END PANEL 2EA</p>	<p>⑤ (197-50611-05)</p>  <p>LEG LEVELER 4EA</p>	<p>⑥ (197-50611-06)</p>  <p>8X30MM LEG BOLT 8EA</p>
<p>⑦ (197-50611-07)</p>  <p>22MM FLAT WASHER 8EA</p>	<p>⑧ (197-50611-08)</p>  <p>3.5X12MM WASHER HEAD SCREW 4EA</p>	<p>⑨ (197-50611-09)</p>  <p>3.5X25MM FLAT HEAD SCREW 4EA</p>	<p>⑩ (197-50611-10)</p>  <p>4X25MM WASHER HEAD BOLT 16EA</p>	<p>⑪ (197-50611-11) PRE-INSTALLED</p>  <p>APRON CORNER 4EA</p>	<p>⑫ (197-50611-12)</p>  <p>PUCK RETURN UNIT 2EA</p>
<p>⑬ (197-50611-13)</p>  <p>PUSHER 2EA</p>	<p>⑭ (197-50611-14)</p>  <p>PUCK 4EA</p>	<p>⑮ (197-50611-15)</p>  <p>LEG SIDE BRACE 2EA</p>	<p>⑯ (197-50611-16)</p>  <p>LCD SCORER 1EA</p>	<p>⑰ (197-50611-17) PRE-INSTALLED</p>  <p>CORNER RAIL 4EA</p>	<p>⑱ (197-50611-18)</p>  <p>ALLEN KEY 1EA</p>
<p>⑲ (197-50611-19) PRE-INSTALLED</p>  <p>HOCKEY MOTOR 1EA</p>	<p>⑳ (197-50611-20)</p>  <p>SLIDE SCORER 2EA</p>	<p>㉑ (197-50611-21)</p>  <p>3.5X18MM ROUND HEAD SCREW 2EA</p>			

Step 1- Assemble Legs

First attach legs #2 and #3 to the main frame of the cabinet using bolts #6 and washers #7.

Step 2-Attach Side and End Panels

Attach end panels #4 using bolts #10. Next attach side panels #15 using bolts #10. To complete leg assembly attach leg levelers #5.

FIG.1

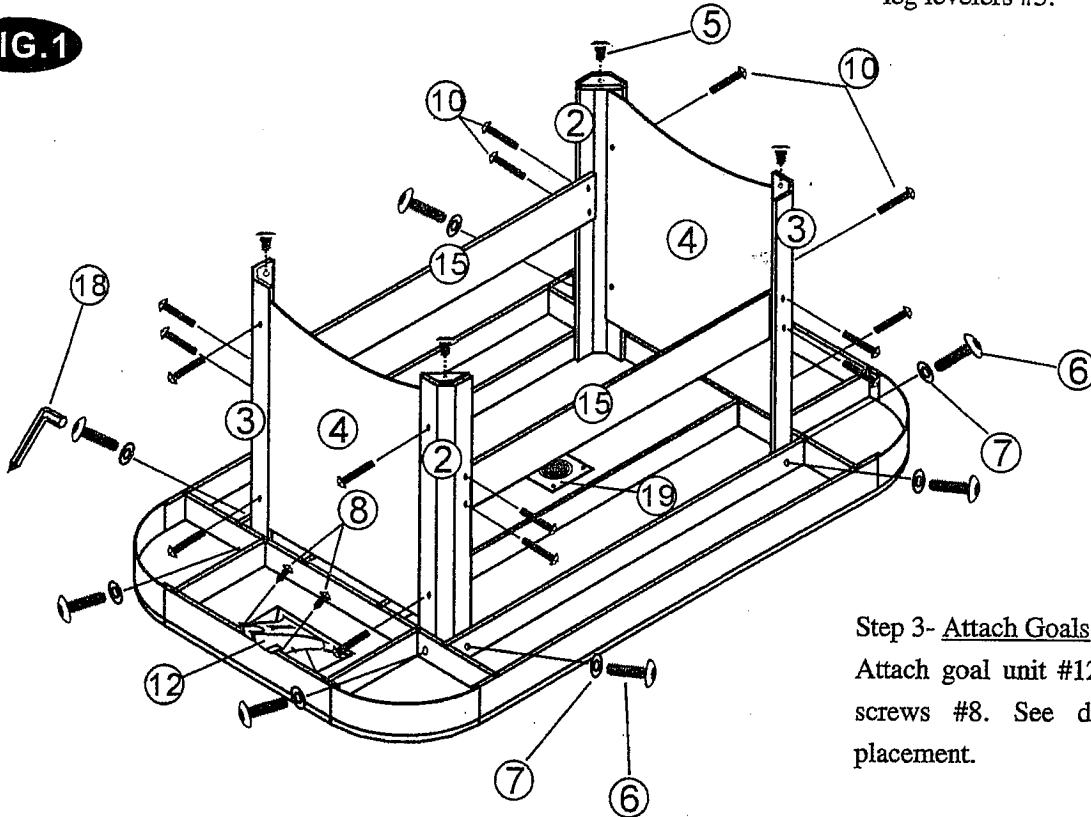

Step 3- Attach Goals

Attach goal unit #12 to each end using screws #8. See diagram for proper placement.

FIG.2

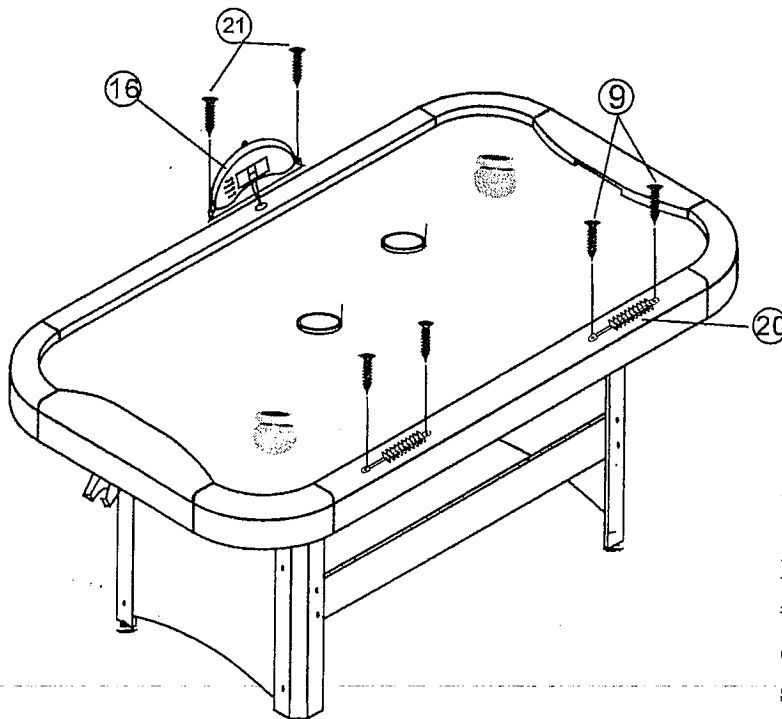

Step 4- Attach Scoring

Flip table to upright position. Attach manual scoring #20 using screws #9 (see diagram for proper placement). Next attach electronic scoring unit #16 using screws #21 (also refer to diagram for proper placement). Be sure to feed wires for electronic scoring unit through pre-drilled hole before securing.

ELECTRONIC SCORING ASSEMBLY STEPS

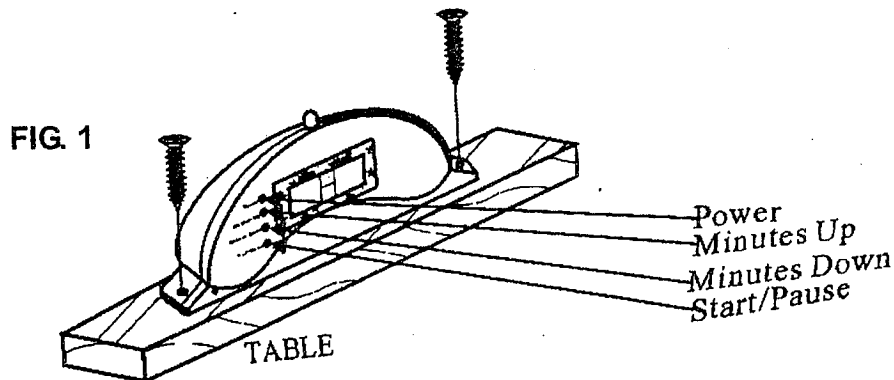

Step 1 – Thread the wires coming from the LCD Scorer through the opening on the Side Apron. Secure the LCD Scorer to the Side Apron using two Screws #9 as shown in Fig. 1. Pilot holes show the proper screw placement.

FIG. 2

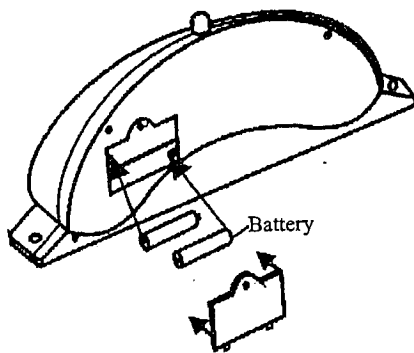

Step 2 – From underneath the table connect the wires from the LCD Scorer to the Puck Return Units. Each of the wires from the Scorer has a male end. Connect one wire to each of the Puck Return Units with the female plug.

Caution: Batteries required for the electronic scorer and not included in the package. Remove the cover from the back of the LCD Scorer and insert the two AA Batteries then attach the cover as shown in Fig. 2.

ELECTRONIC SCORING OPERATIONS

1. Press "Minutes up" and "Minutes down" to select the desired time mode.
2. Press "Start/Pause" key to start the game during the game, press the same button once to pause, press the button again to restart the game.
3. Goal sensors will automatically register the scores to each player.
4. At the end of the game, press "Start/Pause" to start a new round.
5. Press & hold the "Power" 2~3 seconds to switch off the scorer.

CAUTION: THE ELECTRONIC SCORING UNIT HAS THE INFRARED SENSOR. BE AWARED THAT YOU DO NOT PUT OVER 2 PUCKS IN THE PUCK RETURN UNIT; OTHERWISE, THE SCORER CANNOT SCORE PROPERLY.

PARTS ORDER FORM

If for some reason you are missing any assembly parts for your Halex game table, please call the Regent Sports Customer Service line at (1877) 516-9707 (toll free) between the hours of 10:00am and 5:00 pm EST or go online at www.regent-halex.com for parts ordering. Please refer to the REGENT SPORTS LIMITED WARRANTY concerning missing and defective parts.

Parts also may be ordered by filling out the form below. Please fill in all the information and return to:

REGENT SPORTS CORP.
45 RANICK ROAD
HAUPPAUGE, NEW YORK, 11788
ATTN: CUSTOMER SERVICE

REGENT SPORTS CORP. requires that all orders for replacement parts must be paid by check, money order, VISA, or MC. Cash is not accepted. Please make all checks or money orders payable to REGENT SPORTS CORP. *Please note all prices include shipping and handling.*

Name of Purchaser: _____

Address: _____

City: _____

State: _____ **Zip Code:** _____

Phone: _____

Part #	Description	Quantity	Price	Total Cost
197-50611-02	Right Leg	2	\$13.00 each	
197-50611-03	Left Leg	2	\$13.00 each	
197-50611-04	Leg End Panel	2	\$12.00 each	
197-50611-05	Leg Leveler	4	\$5.00 each	
197-50611-06	Leg Bolt 8 x 30mm	8	\$1.50 each	
197-50611-07	Flat Washer 22mm	8	\$1.50 each	
197-50611-08	Washer Head Screw 3.5 x 12mm	4	\$1.50 each	
197-50611-09	Flat Head Screw 3.5 x 25mm	4	\$1.50 each	
197-50611-10	Washer Head Bolt 4 x 25mm	16	\$1.50 each	
197-50611-11	Apron Corner	4	\$5.00 each	
197-50611-12	Puck Return Unit	2	\$5.00 each	
197-50611-13	Competition Pusher	2	\$5.00 each	
197-50611-14	Puck	4	\$2.00 each	
197-50611-15	Leg Side Brace	2	\$10.00 each	
197-50611-16	Electronic Scorer	1	\$15.00 each	
197-50611-17	Corner Rail	4	\$5.00 each	
197-50611-19	Fan	1	\$10.00 each	
197-50611-20	Slide Scorer	2	\$7.00 each	
197-50611-21	Round Head Screw 3.5X18mm	2	\$1.50 each	

Also be sure to check out our web site at:

www.regent-halex.com

• Parts Ordering • Owners Manual • Product Information



© 2007
Regent Sports Corporation
Hauppauge, New York