

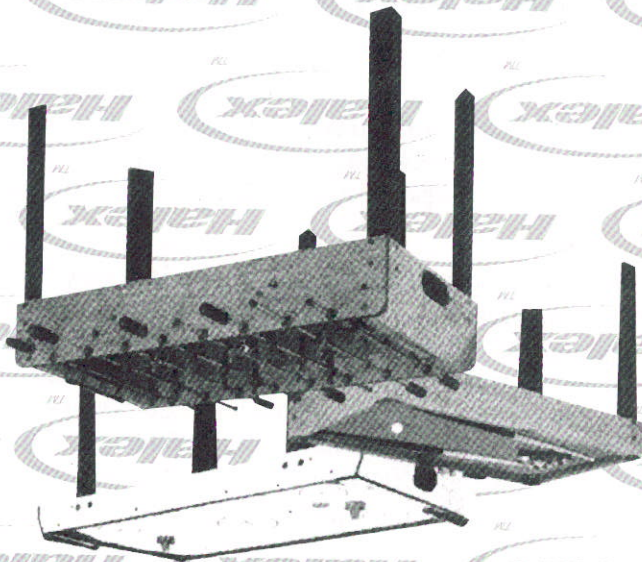

50310



Assembly instructions

Games

TABLE

PLEASE DO NOT RETURN THIS ITEM TO THE STORE!

Should you have a defect or parts issue, please refer to the warranty instructions listed below and contact Regent Sports

at our toll free number!!

LIMITED 90 DAY WARRANTY

This Halex product is warranted to be free from defects in workmanship or materials at the time of purchase for a period of 90 (ninety) days. Certain restrictions apply (see below).

Should any evidence of defects appear within the limited warranty period after the date of purchase, Regent Sports will either send replacement parts or advise of another course of action. A list of replaceable parts can be found on the parts order form page of this manual. Parts not listed on this order form are not replaceable. **Table tops, playing surfaces, and main frames are not replaceable.** This warranty covers normal consumer use and does not cover failures, which result from alterations, accidents, misuse, abuse, or neglect.

For prompt warranty service and special offers, please register your Halex product at our customer service center by visiting our website at: www.regent-halex.com. Enter the following unique registration number followed by the item number of your table found on the cover of this manual: 1ZAK7. You must register your product within 30 days of purchase to be eligible for warranty service. Please make sure to visit our website to order additional parts not covered under the warranty, as well as on-line instruction manuals and new product information. You may also order parts by calling our automated voice recognition system (877) 516-8707.

A purchase receipt or other proof of date of purchase will be required before warranty service is performed. Requests for warranty service can be provided by e-mailing the customer service department at cstables@regent-halex.com or by calling customer service at:













































877-516-9707 (Toll Free)

10:00 AM to 6:00 PM, EST. (Dec. through Jan.)
10:00 AM to 5:00 PM, EST. (Feb. through Nov.)

Or send request in writing to:

Regent Sports Corporation
45 Ranick Road
Hauppauge, NY 11788
Attn: Halex Customer Service

This warranty gives you specific legal rights and you may have other rights that vary from state to state.

| | | | | | | | | | | | | | | | | | |
|----|---|---|----|---|---|----|---|---|----|---|---|----|--|---|----|---|---|
| 1 | SIDE APRON 2 EA |  | 2 | END APRON ASSEMBLY 2 EA |  | 3 | PLAYFIELD 1 EA |  | 4 | LEFT LEG 2EA |  | 5 | RIGHT LEG 2EA |  | 6 | LEG END BRACE 2 EA |  |
| 7 | LEG CENTER BRACE 1 EA |  | 8 | PLAYFIELD SUPPORT BRACE 2 EA |  | 9 | STEEL SUPPORT ROD 2 EA |  | 10 | SUPPOR ROD NUT 4 EA |  | 11 | 1 PLAYER ROD ASSEMBLY YELLOW/BLACK 1 EA |  | 12 | 2 PLAYER ROD ASSEMBLY YELLOW/BLACK 1 EA |  |
| 13 | 3 PLAYER ROD ASSEMBLY YELLOW/BLACK 1 EA |  | 14 | 5 PLAYER ROD ASSEMBLY YELLOW/BLACK 1 EA |  | 15 | 1 PLAYER ROD ASSEMBLY GREEN/YELLOW 1 EA |  | 16 | 2 PLAYER ROD ASSEMBLY GREEN/YELLOW 1 EA |  | 17 | 3 PLAYER ROD ASSEMBLY GREEN/YELLOW 1 EA |  | 18 | 6 PLAYER ROD ASSEMBLY GREEN/YELLOW 1 EA |  |
| 19 | PRE-INSTALLED PLAYER YELLOW/BLACK 11EA |  | 20 | PRE-INSTALLED PLAYER GREEN/YELLOW 11EA |  | 21 | PRE-INSTALLED RUBBER BUMPER 16EA |  | 22 | HAND GRIP 8EA |  | 23 | PRE-INSTALLED PLASTIC PLAYER ROD WASHER 16 EA |  | 24 | SLIDE SCORER 2EA |  |
| 25 | SOCCER BALLS 4EA |  | 26 | PRE-INSTALLED PLAYER ROD BUSHING 16EA |  | 27 | PRE-INSTALLED BALL ENTRY RING 2 EA |  | 28 | PRE-INSTALLED GOAL 2 EA |  | 29 | PRE-INSTALLED SIDE BALL RETURN RING 2EA |  | 30 | ALLEN KEY 1EA |  |
| 31 | 8X30MM LEGBOLT 12 EA |  | 32 | 22MM FLAT WASHER 12EA |  | 33 | 3.5x10.5MM WASHER HEAD SCREW 38EA |  | 34 | 3.5X33MM FLAT HEAD SCREW 12EA |  | 35 | 4 X25MM WASHER HEAD BOLT 8EA |  | 36 | 3.5X25MM FLAT HEAD SCREW 4EA |  |
| 37 | 3.5X28MM WASHER HEAD SCREW 4EA |  | 38 | PLASTIC SCREW 8EA |  | 39 | PLASTIC LEG CAP 4EA |  | 40 | PLAYER ROD CAP 8EA |  | 41 | PLASTIC CORNER - RIGHT 2EA |  | 42 | PLASTIC CORNER - LEFT 2EA |  |
| 43 | SIDE BALL RETURN TRAY 2 EA |  | 44 | LEG LEVELER 4EA |  | 45 | PRE-INSTALLED STOP RING 4EA |  | | | | | | | | | |

**SOCCER TABLE
50310
PARTS LIST**

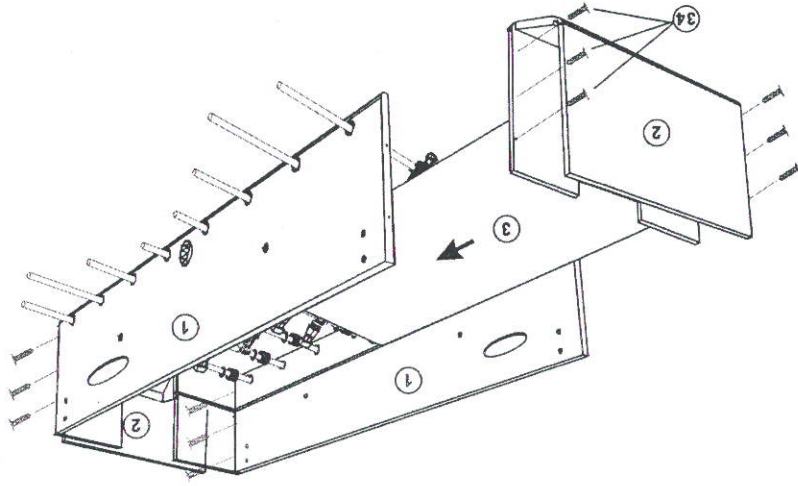

FIG:2

Step 2- Place opposite side panel #1 over other ends of player rods. Next attach end panel #2 to one end. Secure with screws #34. Be sure to use pre-drilled holes. Next slide in play surface #3 into pre cut slots in side and end panel. Next attach remaining end panel #2 also using screws #34.

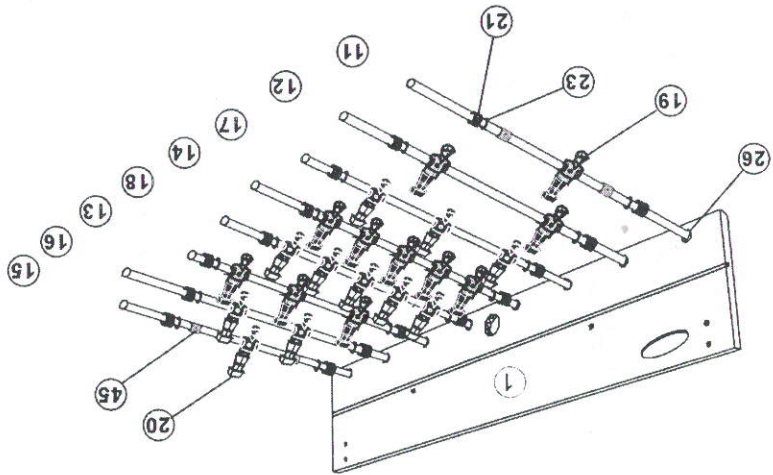

FIG:1

Step 1- Insert players into side panel #1. Place side panel upside down and follow the diagram for proper placement of the player rods.

Step 3- Attach ball return trays #43 from end panel to side panels using screws # 33. Next attach support braces # 8 by lining them up with the predrilled holes on the side panels and sliding support rods # 9 through brace and securing with rod nuts # 10.

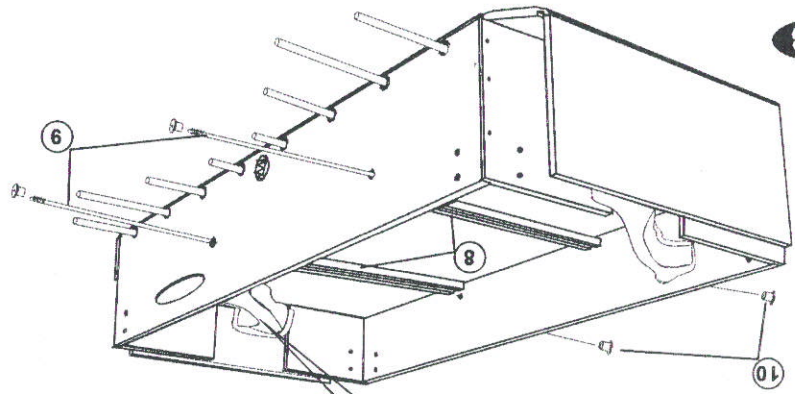

FIG:3

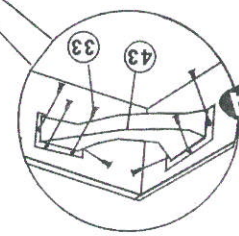

FIG.3A

Step 4- attach legs # 4 and #5 to the frame assembly using bolts #31 and washers #32. Next attach plastic leg cap #39 to each leg using screws #38.

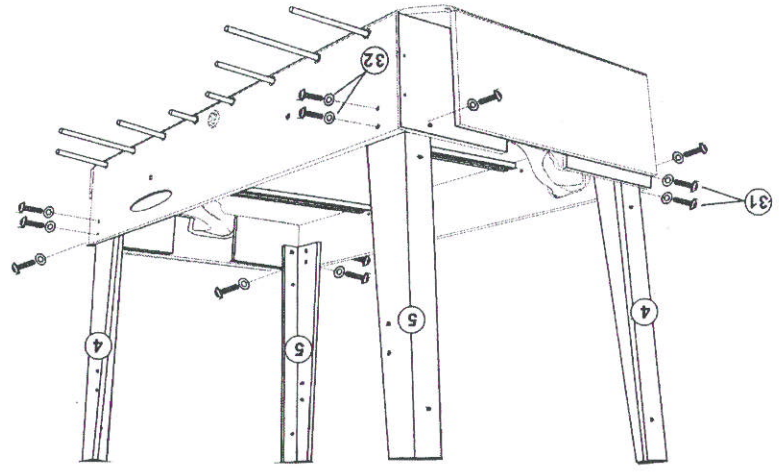
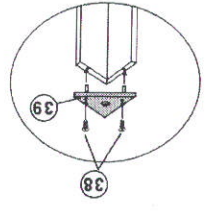

FIG:4



38

39

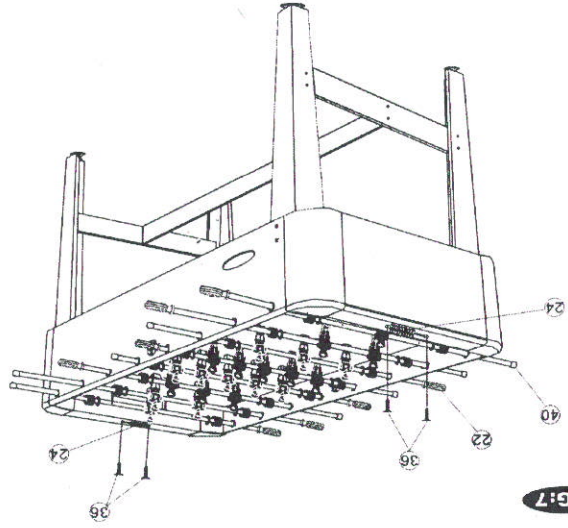

FIG:7

Step 7- Attach scoring units #24 to each end using screws #36. Finally place end caps #40 and handles #22 to each rod.

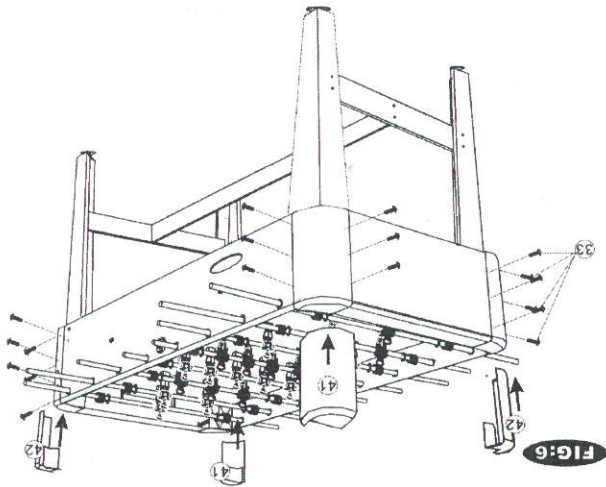

FIG:6

Step 6- Attach corner pieces #41 and #42. Slide in place following diagram and secure with screws #33.

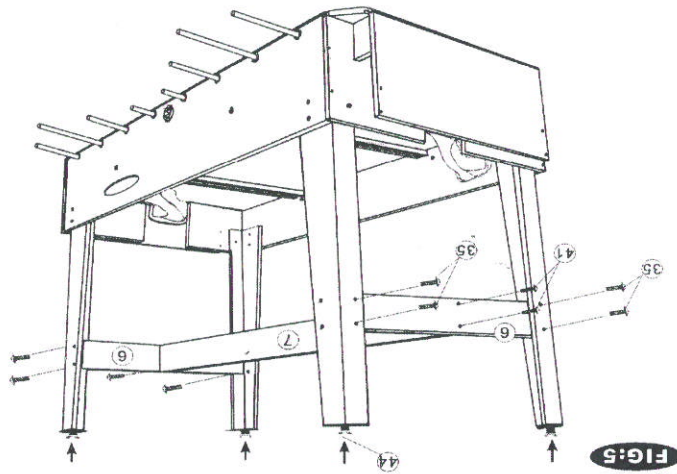

FIG:5

Step 5- Attach leg panels #6 and #7. First attach panels #6 to each leg assembly using screws #35. Next attach center panel #7 using screws #35. Next screw in leg levelers #44 into each leg.