

NOTICE DE MONTAGE
ASSEMBLY INSTRUCTIONS

Cooper®

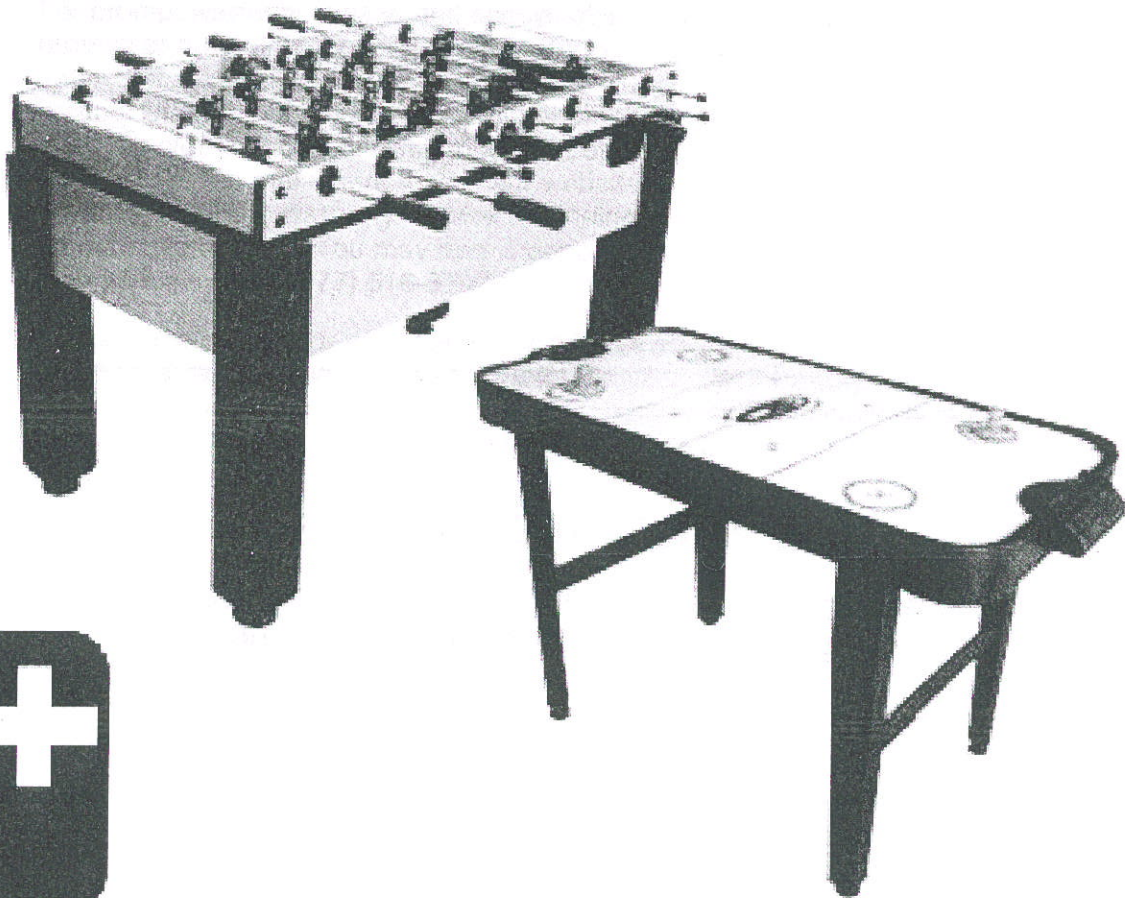

6+

50302

Should you have a defect or parts issue, please refer to the warranty instructions listed below and contact Cooper at our toll free number!!

LIMITED 90 DAY WARRANTY

This Cooper product is warranted to be free from defects in workmanship or materials at the time of purchase for a period of 90 (ninety) days. Certain restrictions apply (see below).

Should any evidence of defects appear within the limited warranty period after the date of purchase, Cooper will either send replacement parts or advise of another course of action. A list of replaceable parts can be found on the parts order form page of this manual. Parts not listed on this order form are not replaceable. **Table tops, playing surfaces, and main frames are not replaceable.** This warranty covers normal consumer use and does not cover failures, which result from alterations, accidents, misuse, abuse, or neglect.

For prompt warranty service and special offers, please register your Cooper product at our customer service center by visiting our website at: www.regent-halex.com. Enter the following unique registration number followed by the item number of your table found on the cover of this manual: 1ZAK7 _____. You must register your product within 30 days of purchase to be eligible for warranty service. Please make sure to visit our website to order additional parts not covered under the warranty, as well as on-line instruction manuals and new product information. You may also order parts by calling our automated voice recognition system (877) 516-8707.

A purchase receipt or other proof of date of purchase will be required before warranty service is performed. Requests for warranty service can be provided by e-mailing the customer service department at cstables@regent-halex.com or by calling customer service at:

877-516-9707 (Toll Free)

10:00 AM to 6:00 PM, EST. (Dec. through Jan.)











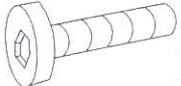
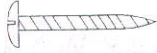

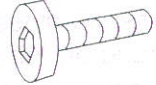



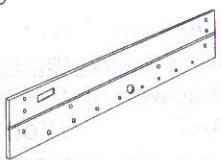
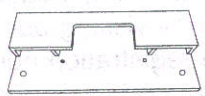

10:00 AM to 5:00 PM, EST. (Feb. through Nov.)

Or send request in writing to:

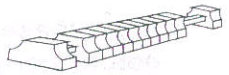
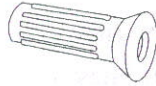
Regent Sports Corporation
45 Ranick Road
Hauppauge, NY 11788
Attn: Cooper Customer Service

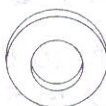

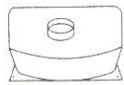
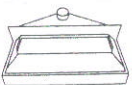
soccer table Assemble Manual

Parts List for All Soccer Table 50302

<p>#1</p>  <p>1/4"(0.635cm) bolt 4Pieces</p>	<p>#2</p>  <p>3/18"(0.423cm) Round head screw 4pieces</p>	<p>#3</p>  <p>1/8"(0.3175cm) Round head screw 16pieces</p>	<p>#4</p>  <p>3/18"(0.423cm) Round head screw 12pieces</p>
<p>#5</p>  <p>5/16"(0.794cm) bolt 16Pieces</p>	<p>#6</p>  <p>5/16"(0.794cm) washer 16pieces</p>	<p>#7</p>  <p>Leg leveler 4 pieces</p>	<p>#8</p>  <p>1/4"(0.635cm) barrel nut 4pieces</p>
<p>#9</p>  <p>Side panel 2 pieces</p>	<p>#10</p>  <p>End panel 2 pieces</p>	<p>#11</p>  <p>Right leg 2 pieces</p>	<p>#12</p>  <p>Left leg 2 pieces</p>
<p>#13</p>  <p>Playing field 1 piece</p>	<p>#14</p>  <p>Playfield support brace 2 pieces</p>	<p>#15</p>  <p>Leg End Panel 2 pieces</p>	<p>#16</p>  <p>Slide scorer 2 pieces</p>
<p>#17</p>  <p>Handle 8 pieces</p>	<p>#18</p>  <p>Rod end cap 8 pieces</p>	<p>#19</p>  <p>Plastic rod washer 16 pieces</p>	<p>#20</p>  <p>Rubber rod bushing 16 pieces</p>
<p>#21</p>  <p>Plastic ball catcher 2 pieces</p>	<p>#22</p>  <p>Plastic goal box 2 pieces</p>	<p>#23</p>  <p>Ball runner 2 pieces</p>	<p>#24</p>  <p>Soccer ball 2 pieces</p>

soccer table Assemble Manual

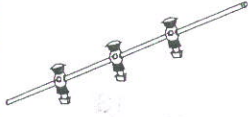
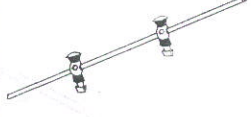
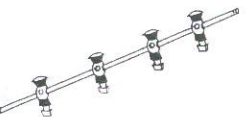
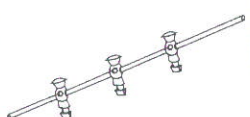
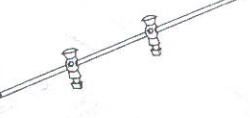
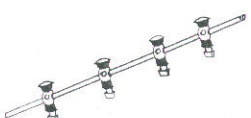
Parts List for All Soccer Table

<p>#25</p>  <p>Yellow 3-player rod 2 pieces</p>	<p>#26</p>  <p>Yellow 2-player rod 1 piece</p>	<p>#27</p>  <p>Yellow 4-player rod 1 piece</p>	<p>#28</p>  <p>Red 3-player rod 2 pieces</p>
<p>#29</p>  <p>Red 2-player rod 1 piece</p>	<p>#30</p>  <p>Red 4-player rod 1 piece</p>	<p>#31</p>  <p>Allen wrench 1 piece</p>	<p>#32</p>  <p>1/4"(0.635cm) washer 4pieces</p>

Step 1- Place Plastic Rod Washer #19 and Rubber Rod Bushing #20 on all Player Rods. Insert Player Rods (follow order shown) into side panel #9. (Place side Panel upside down so the holes for the men are closest to the floor before inserting the men)

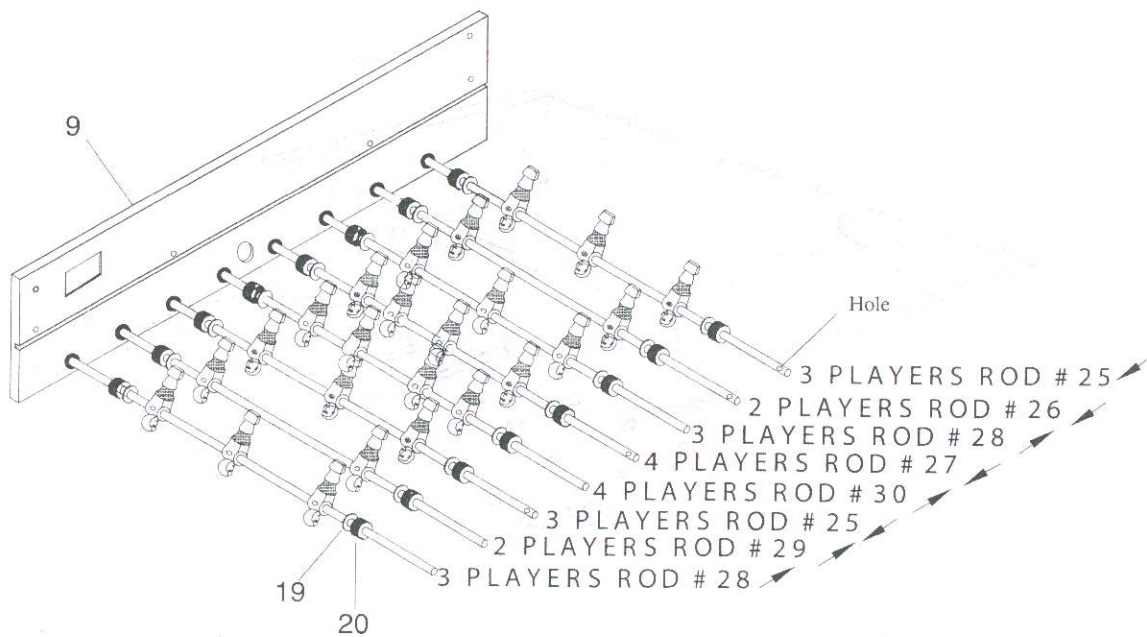

Step 2- Place other side panel #9 over other end of rods. Insert Playing field #13 (upside down) into side panels.

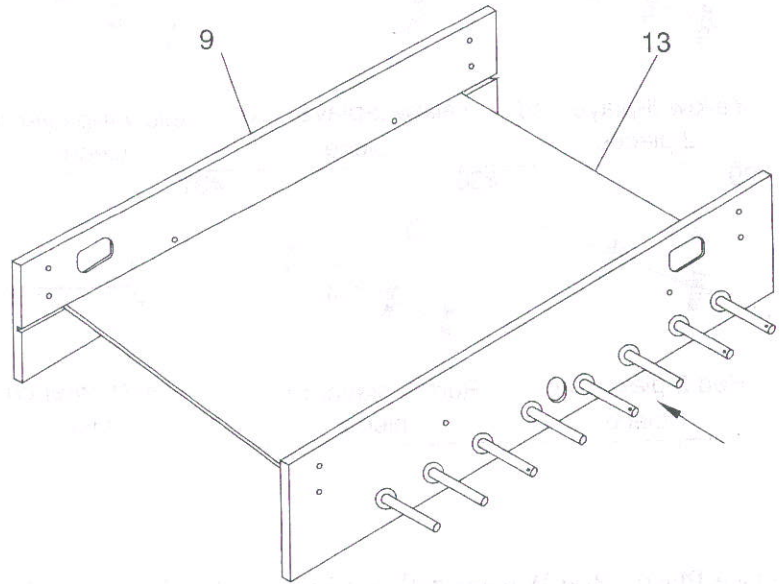

Step 3- Attach End Panels # 10 to each end of the table using Bolts #5 and Washers #6.

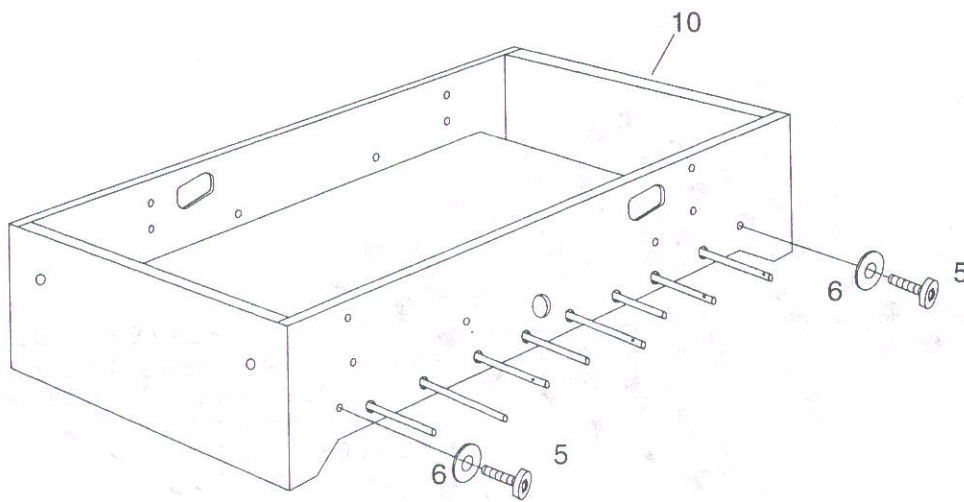

Step 4- Screw down playing field using screws #3 making sure that you use the pre-drilled holes. Next attach playfield Support Brace #14 using Barrel Nut #8 Bolt # 1 and Washer # 32.

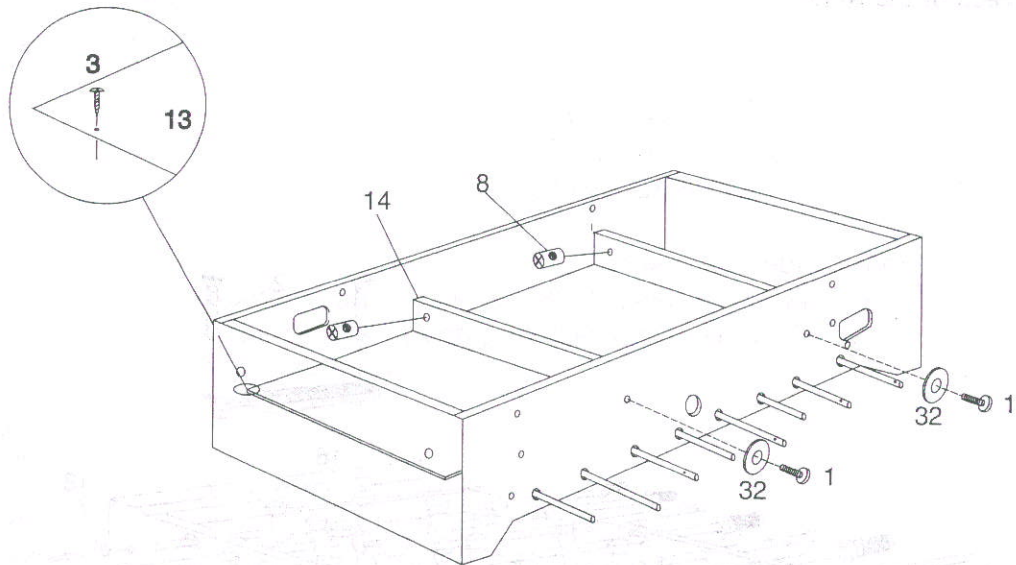

Step 5- Attach Legs #11 and #12 using Bolts #5 and Washers #6. Next attach plastic goal catcher #21 and plastic goal box #22 using screws #4. Next attach Ball Runner #23 to the Plastic Goal Box and plastic Ball Catcher. Next attach End Panels #15 using Screws #3. Screw the leg levelers (#7) into the bottom of the legs.

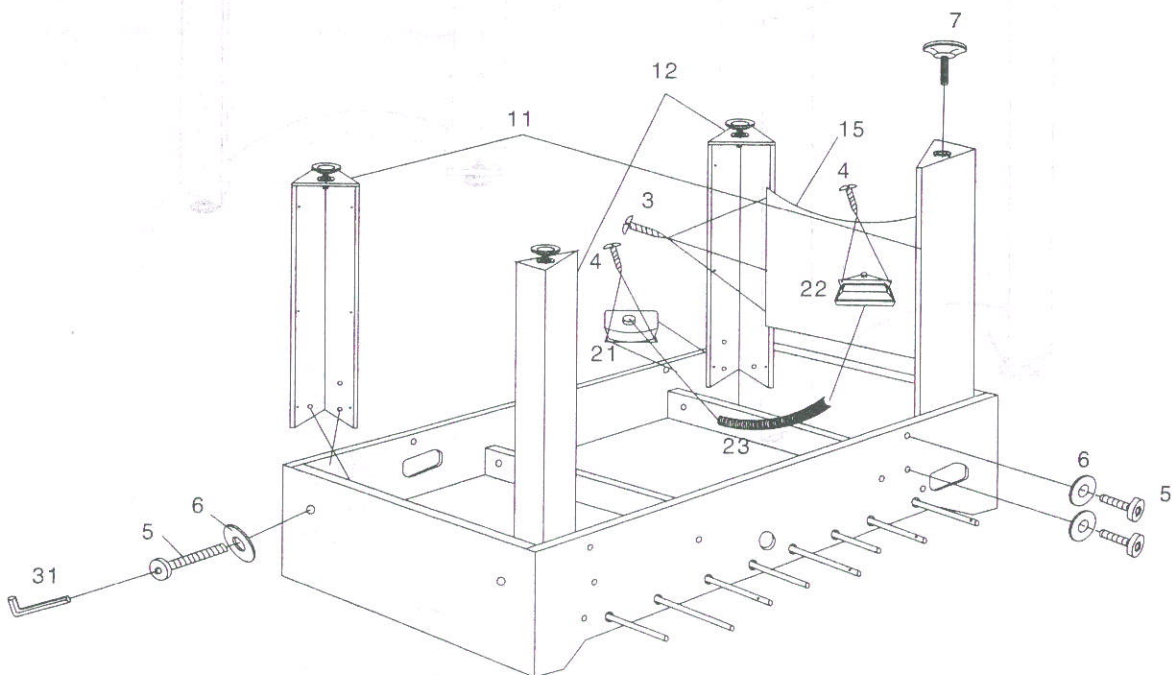

Step 6- Attach slide scorer #16 using Screws #2. Next attach Handle #17 and rod End Caps#18 to each of the Rods.

