

Halex Halex Halex HA

Halex Halex Halex Halex

TABLE

Games

Assembly instructions

Halex Halex Halex Halex

Halex Halex Halex Halex

Halex Halex Halex Halex

Halex Halex Halex Halex

Halex Halex Halex Halex

Halex Halex Halex Halex

Halex Halex Halex Halex

Halex Halex Halex Halex

Halex Halex Halex Halex

Halex Halex Halex Halex



50203



LIMITED 90 DAY WARRANTY

This Halex product is warranted to be free from defects in workmanship or materials at the time of purchase for a period of 90 (ninety) days. Certain restrictions apply (see below).

Should any evidence of defects appear within the limited warranty period after the date of purchase, Regent Sports will either send replacement parts or advise of another course of action. A list of replaceable parts can be found on the parts order form page of this manual. Parts not listed on this order form are not replaceable. **Table tops, playing surfaces, and main frames are not replaceable.** This warranty covers normal consumer use and does not cover failures, which result from alterations, accidents, misuse, abuse, or neglect.

For prompt warranty service and special offers, please register your Halex product at our customer service center by visiting our website at: www.regent-halex.com. Enter the following unique registration number followed by the item number of your table found on the cover of this manual: 1ZAK7 _____. You must register your product within 30 days of purchase to be eligible for warranty service. Please make sure to visit our website to order additional parts not covered under the warranty, as well as on-line instruction manuals and new product information. You may also order parts by calling our automated voice recognition system at: 877-516-9707 (Toll Free).

A purchase receipt or other proof of date of purchase will be required before warranty service is performed. Requests for warranty service can be provided by e-mailing the customer service department at cstables@regent-halex.com or by calling customer service at:

877-516-9707 (Toll Free)

10:00 AM to 6:00 PM, EST. (Dec. through Jan.)















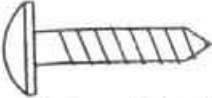



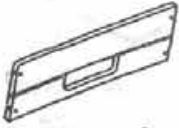
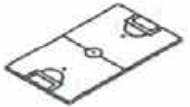

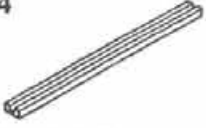

10:00 AM to 5:00 PM, EST. (Feb. through Nov.)

Or send request in writing to:











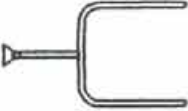

**Regent Sports Corporation
45 Ranick Road
Hauppauge, NY 11788
Attn: Halex Customer Service**

This warranty gives you specific legal rights and you may have other rights that vary from state to state.

Parts List for 50203 Table

<p>#1</p>  <p>5/16" Bolt 8 pieces</p>	<p>#2</p>  <p>5/16" Washer 8 pieces</p>	<p>#3</p>  <p>3/16" Bolt 16 pieces</p>	<p>#4</p>  <p>3/16" Washer 16 pieces</p>
<p>#5</p>  <p>1/2" Round Head Screw 8 pieces</p>	<p>#6</p>  <p>1/4" Locknut 4 pieces</p>	<p>#7</p>  <p>1/4" Washer 4 pieces</p>  <p>Support Rod 2 pieces</p>	<p>#8</p>  <p>Side Panel 2 pieces</p>
<p>#9</p>  <p>Goal Panel 2 pieces</p>	<p>#10</p>  <p>Playing Field 1 piece</p>	<p>#11</p>  <p>Left Leg 2 pieces</p>	<p>#12</p>  <p>Right Leg 2 pieces</p>
<p>#13</p>  <p>Cross Panel 2 pieces</p>	<p>#14</p>  <p>Playfield Support Brace 2 pieces</p>	<p>#15</p>  <p>Goal (1) 2 pieces</p>	<p>#16</p>  <p>Goal (2) 2 pieces</p>
<p>#17</p>  <p>Handle 8 pieces</p>	<p>#18</p>  <p>Rod End Cap 8 pieces</p>	<p>#19</p>  <p>3 Home Players Rod 2 pieces</p>	<p>#20</p>  <p>3 Home Players Rod 1 piece</p>
<p>#21</p>  <p>2 Home Players Rod 1 piece</p>	<p>#22</p>  <p>3 Away Players Rod 2 pieces</p>	<p>#23</p>  <p>3 Away Players Rod 1 piece</p>	<p>#24</p>  <p>2 Away Players Rod 1 piece</p>

Parts List for 50203 Table

<p>#25</p>  <p>Soccer Ball 2 pieces</p>	<p>#26</p>  <p>Tool 1 piece</p>	<p>#27</p>  <p>Tool 2 pieces</p>	<p>#28</p>  <p>Shuffle Puck 6 pieces</p>
<p>#29</p>  <p>Fooball Goal 1 piece</p>	<p>#30</p>  <p>Pole 1 piece</p>	<p>#31</p>  <p>Football Puck 2 pieces</p>	<p>#32</p>  <p>Ring 2 pieces</p>
<p>#33</p>  <p>Bowling Pin 10 pieces</p>	<p>#34</p>  <p>Bowling Ball 1 piece</p>	<p>#35</p>  <p>Play Card 1 piece</p>	<p>#36</p>  <p>Game Board 1 piece</p>

ASSEMBLY INSTRUCTIONS

WARNING: TWO ADULTS NEEDED TO ASSEMBLE SOCCER TABLE

IMPORTANT:

Please read through the instruction book before attempting assembly to familiarize yourself with all part and assembly steps

Step 1 - Cut the corners of the box and place it on the floor to protect the parts as the unit is being constructed. Place the side panels (8) upside down with the slot facing inward as FIGURE 1 shows. To ease assembly push the pre-assembled springs and washers on the rods completely up against the men. Do not remove the rubber bands that hold the assembly together yet. Insert the rods through the rod bushings in one side panel (8) as shown in FIGURE 1. The small holes in the end of rods 22, 23, & 24 should be through the side panel.

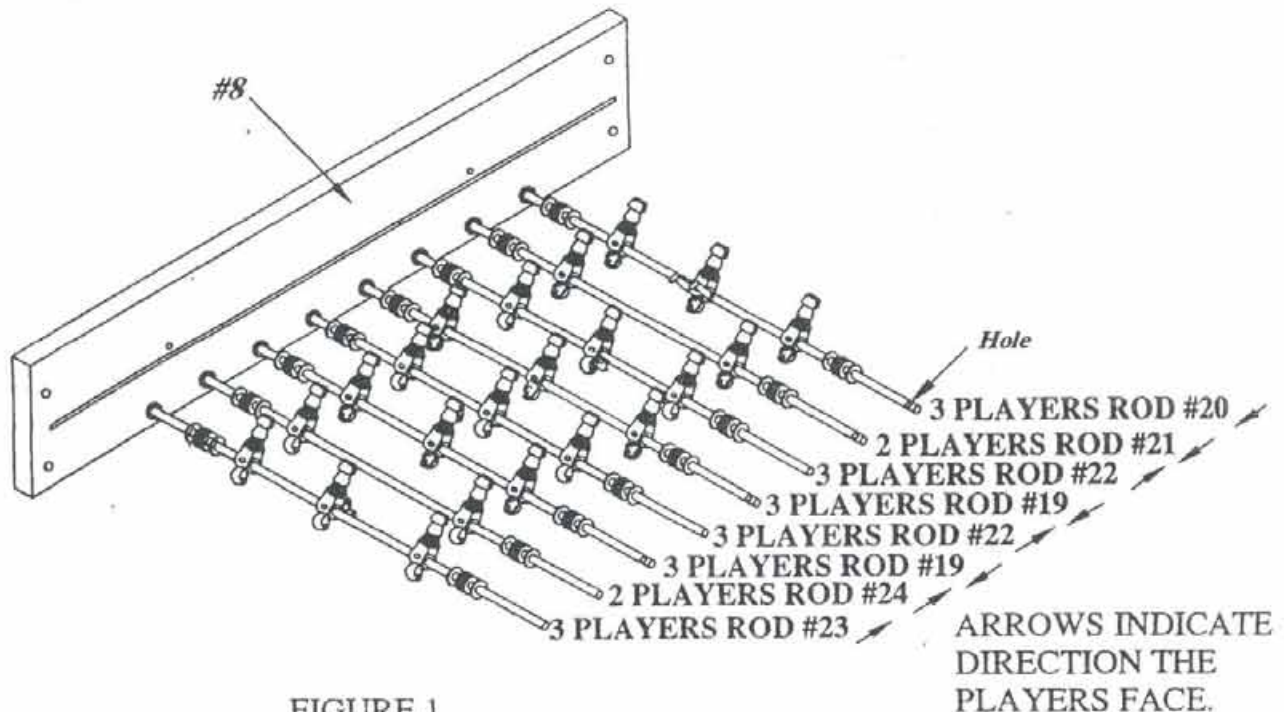
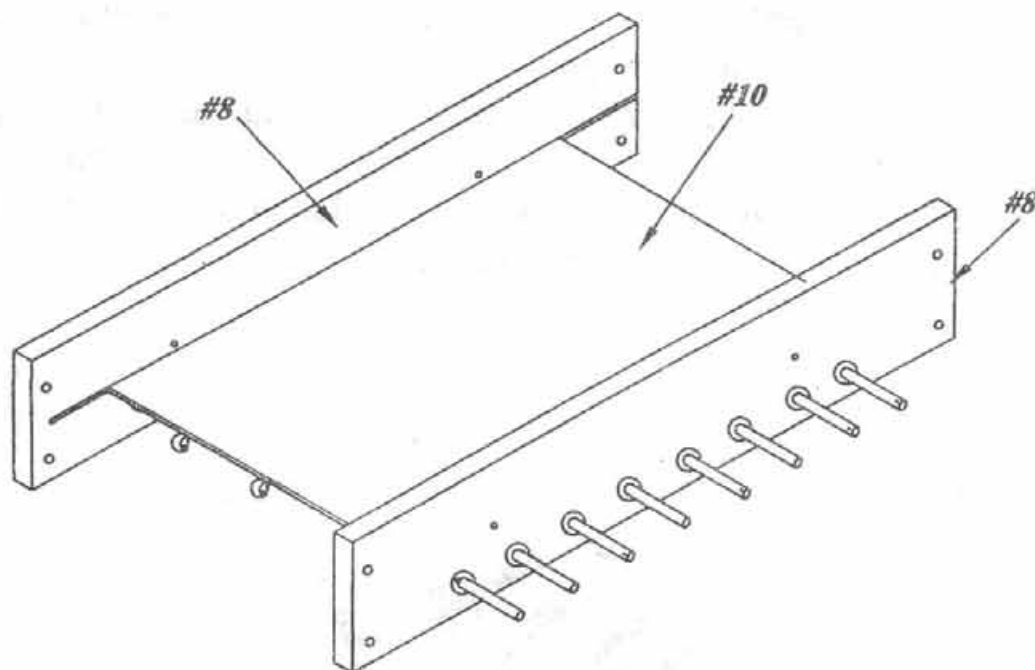

FIGURE 1

ASSEMBLY INSTRUCTIONS

WARNING: TWO ADULTS NEEDED TO ASSEMBLE SOCCER TABLE

Step 2 - Slide the remaining player rods through the other side panel.
Insert the playfield (10) into the grooves in the side panels.
The playfield should be upside down during this step.



ASSEMBLY INSTRUCTIONS

WARNING: TWO ADULTS NEEDED TO ASSEMBLE SOCCER TABLE

Step 3 - Attach the end panels (9) to the side panels using the 3/16" bolt (3) and 3/16" washer (4). Make sure the playfield is completely resting in the grooves in the side and end panels before securing all the way. Place the playfield supports (14) on the playfield. Slide the support rod (7) through the side panel so it rests in the playfield support. Tighten with the 1/4" locknut (6). Attach the right and left legs (11 & 12) to the side panels using the 5/16" bolt (1) and 5/16" washer (2). Place the cross panels (13) between the legs as shown in and tighten with the 3/16" bolt (3) and 3/16" washer (4).

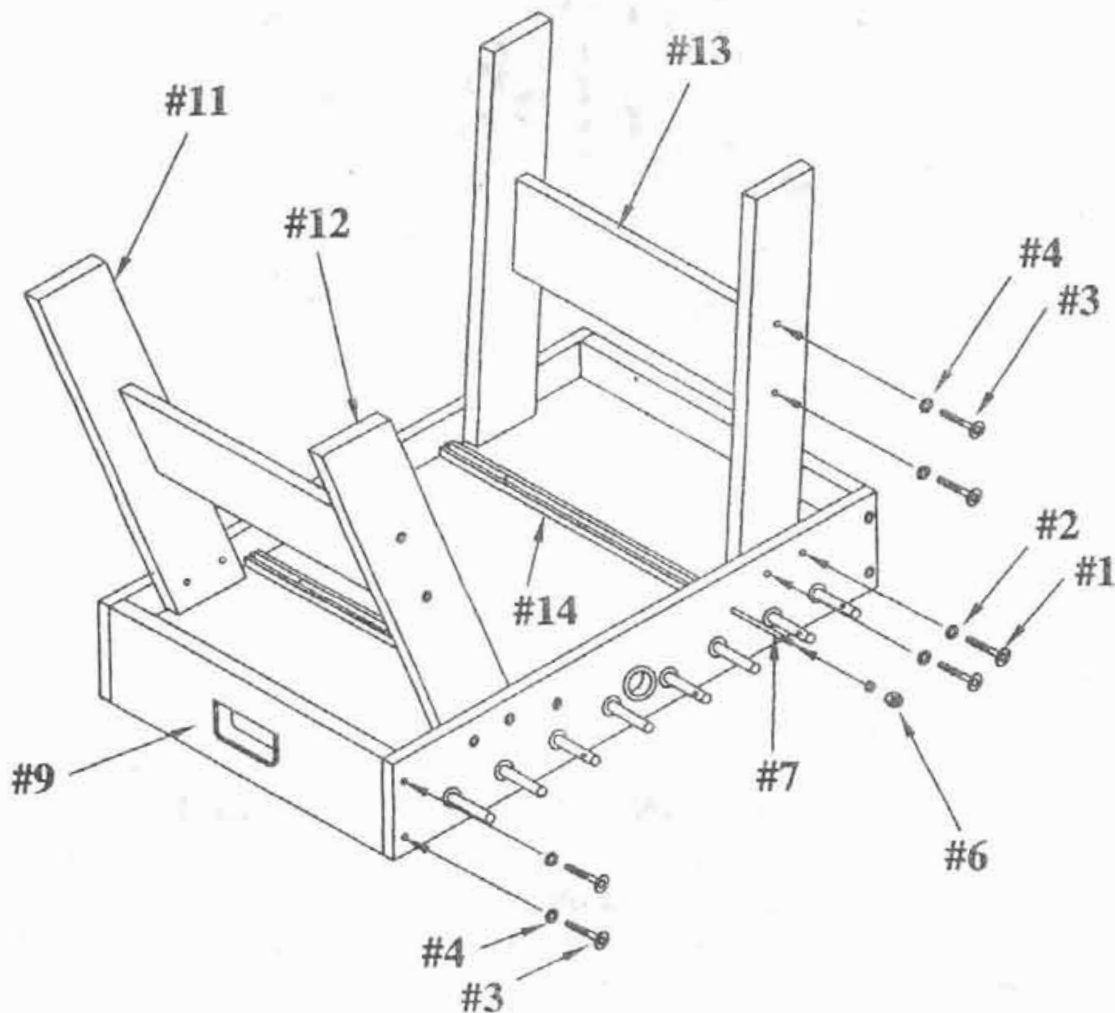

ASSEMBLY INSTRUCTIONS

WARNING: TWO ADULTS NEEDED TO ASSEMBLE SOCCER TABLE

Step 4 - with the help of another adult, carefully flip the table over. Attach goal 1 (15) and goal 2 (16) to the end panel with the $\frac{1}{2}$ " round head screws (5). slide the handles (17) over the ends of the rods with the small holes in them. Slide the rod end caps (18) over the ends of the rods opposite the handles.

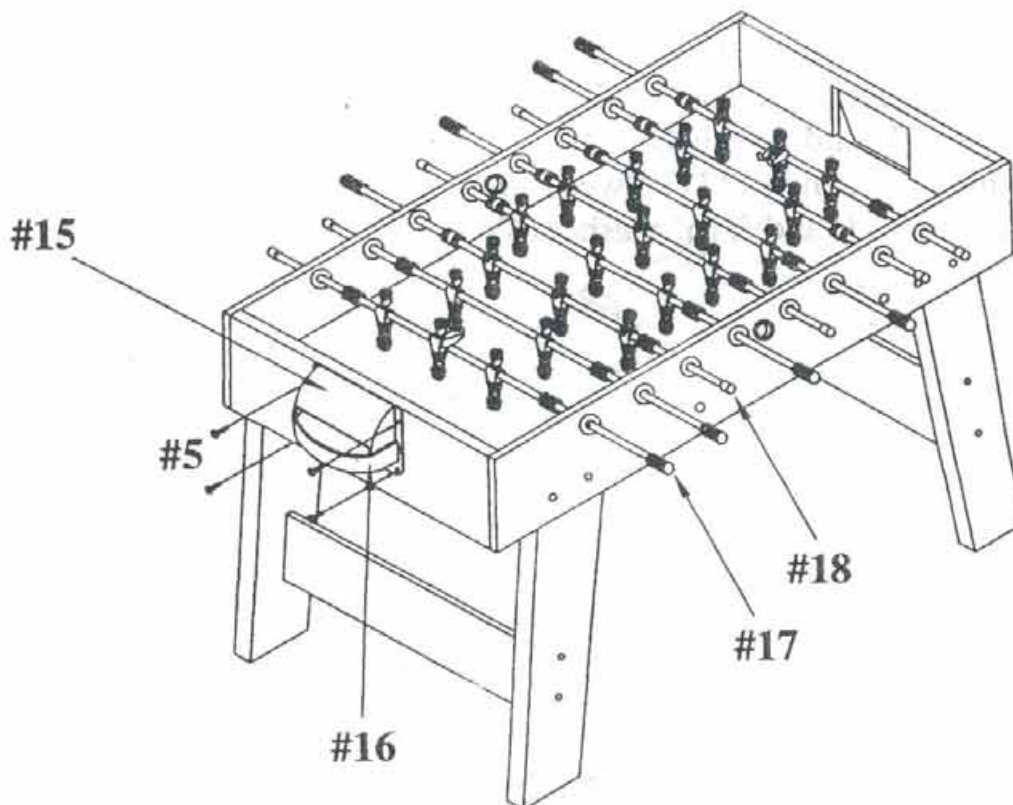

CARE AND USE OF YOUR TABLE

1. Apply spray furniture polish to a clean cloth and wipe down the rods to make them slide easier in the bushings.
2. Use spray furniture polish to clean all exterior surfaces of your game table.
3. This product is intended for INDOOR use only.
4. DO NOT sit, climb or lean on the table.
5. DO NOT drag the table when moving it. This will damage the legs

Foosball Table Game Rules

To Start a Match:

- A coin flip shall precede the start of the match. The team that wins the flip has the choice of table side or first serve.

The Serve:

- A serve through the serving hole is used to put the ball into play at the start of the match, after a point is scored, or after a ball leaves the table.

Subsequent Serves:

- Following the first serve of the match, subsequent serves shall be made by the team last scored upon.

Ball in Play:

- Once a ball is put in play by the server, it shall remain in play until the ball is hit off the table, a dead ball is declared, time out is called, or a point is scored.

Ball Off the Table:

- The ball should be put back into play with a serve by the team which originally served that ball.

Dead Ball:

- A ball shall be declared dead when it has completely stopped its motion and is not within reach of any player figure.
- If the ball is declared dead between the goalie and the 2-man rods, it shall be put back into play by placing the ball in the corner nearest the spot of the dead ball.
- If the ball is declared dead anywhere else on the table, it shall be put back into play with a serve by the team that originally served that ball.

Point Scored:

- A ball entering the goal shall count as a point, as long as it was legally scored. A ball which enters the goal but returns to the playing surface and/or leaves the table still counts as a goal.

Change of Positions:

- In any doubles event, each player may play only the two rods normally designated for his position. Once the ball is put into play, the players must play the same position until a point is scored.

Spinning the Rods:

- Spinning the rods is illegal. Spinning is defined as the rotation of any soccer figure more than 360 degrees before or after striking the ball.
- If the ball goes in the goal, then it will not be counted as a point and will be put back into play by the goalie as if the ball had been declared a dead ball between the goal and the nearest two-man rod.

Jarring:

- Any jarring, sliding, or lifting of the table shall be illegal.

Reaching Into The Playing Area:

- It is illegal for a player to reach into the playing area while the ball is in play.

PARTS ORDER FORM

If for some reason you are missing any assembly parts for your Halex game table, please call the Regent Sports Customer Service line at (877) 516-9707 (toll free) between the hours of 10:00am and 5:00 pm EST or go online at www.regent-halex.com for parts ordering. Please refer to the REGENT SPORTS LIMITED WARRANTY concerning missing and defective parts.

Parts also may be ordered by filling out the form below. Please fill in all the information and return to:

REGENT SPORTS CORP.
45 RANICK ROAD
HAUPPAUGE, NEW YORK, 11788
ATTN: CUSTOMER SERVICE

REGENT SPORTS CORP. requires that all orders for replacement parts must be paid by check, money order, VISA, or MC. Cash is not accepted. Please make all checks or money orders payable to REGENT SPORTS CORP. *Please note all prices include shipping and handling.*

Name of Purchaser: _____
Address: _____
City: _____
State: _____ Zip Code: _____
Phone: _____

Part #	Description	Quantity	Price	Total Cost
195-50203-1	5/16" bolt		\$10.00	
195-50203-2	5/16" washer		\$10.00	
195-50203-3	3/16" bolt		\$7.50	
195-50203-4	3/16" washer		\$7.50	
195-50203-5	1/2" round head screw		\$5.00	
195-50203-6	1/4" lock nut		\$3.50	
195-50203-7	support rod		\$1.00	
195-50203-8	side panel		\$1.00	
195-50203-9	end panel		\$1.00	
195-50203-10	playfield		\$1.00	
195-50203-11	left leg		\$1.00	
195-50203-12	right leg		\$1.00	
195-50203-13	cross panel		\$3.50	
195-50203-14	playfield support brace		\$3.50	
195-50203-15	goal 1		\$3.50	
195-50203-16	goal 2		\$1.00	
195-50203-17	handle		\$2.00	
195-50203-18	rod end cap		\$2.00	
195-50203-19	home 3-player rod		\$5.00	
195-50203-20	home 3-player rod		\$2.00	
195-50203-21	home 2-player rod		\$2.00	
195-50203-22	away 3-player rod		\$2.00	
195-50203-23	away 3-player rod		\$2.00	
195-50203-24	away 2-player rod		\$5.00	
300-1008	soccer ball		\$5.00	
300-10016	shuffle puck		\$2.00 ea	
300-10013	football goalpost		\$2.00	
300-10017	pole		\$2.00	
300-10012	finger flick football		\$2.00	
195-50203-32	ring		\$2.00	
300-10014	bowling pin		\$2.00 ea	
300-10015	bowling ball		\$2.00	
300-10038	playing cards		\$5.00	
195-50203-36	game board		\$7.50	