

CARE AND USE OF YOUR TABLE

WARNING: To avoid the risk of electric shock or injury to persons, do not touch the electrical parts of the table. If you are not a qualified electrician, do not attempt to repair or modify the table. For more information, see the user manual.

Halex **Halex** **Halex** **Ha**

Halex **Halex** **Halex** **Halex**

TABLE
Games

Assembly instructions

Halex **Halex** **Halex** **Ha**

Halex **Halex** **Halex** **Ha**

Halex **Halex** **Halex** **Ha**

Halex **Halex** **Halex** **Ha**

Halex **Halex** **Halex** **Ha**

Halex **Halex** **Halex** **Ha**

Halex **Halex** **Halex** **Ha**

Halex **Halex** **Halex** **Ha**

Halex **Halex** **Halex** **Ha**

Halex **Halex** **Halex** **Ha**

Halex **Halex** **Halex** **Ha**

Halex **Halex** **Halex** **Ha**

Halex **Halex** **Halex** **Ha**

Halex **Halex** **Halex** **Ha**

Halex **Halex** **Halex** **Ha**

Halex **Halex** **Halex** **Ha**

Halex **Halex** **Halex** **Ha**



50202



CARE AND USE OF YOUR TABLE

WARNING: To reduce the risk of fire, electric shock or injury to persons, use this unit only in the manner intended by the manufacturer. If you have any question, contact the manufacturer. Before servicing or cleaning the unit, switch the power off and unplug the adapter from the wall outlet.

This appliance has a polarized plug (one blade is wider than the other). To reduce the risk of electric shock, this plug is intended to fit in a polarized outlet only one way. If the plug does not fit fully in the outlet, reverse the plug. If it still does not fit, contact a qualified electrician. **DO NOT** attempt to defeat this safety feature.

1. Use spray furniture polish to clean all exterior surfaces of your game table.
2. Use only a suitable 120v AC household outlet.
3. This product is intended for INDOOR use only.
4. **DO NOT** sit, climb or lean on the table.
5. **DO NOT** drag the table when moving it. This will damage the leg.
6. The fan should be unplugged before cleaning and servicing.



50502

Hallex

LIMITED 90 DAY WARRANTY

This Halex product is warranted to be free from defects in workmanship or materials at the time of purchase for a period of 90 (ninety) days. Certain restrictions apply (see below).

Should any evidence of defects appear within the limited warranty period after the date of purchase, Regent Sports will either send replacement parts or advise of another course of action. A list of replaceable parts can be found on the parts order form page of this manual. Parts not listed on this order form are not replaceable. **Table tops, playing surfaces, and main frames are not replaceable.** This warranty covers normal consumer use and does not cover failures, which result from alterations, accidents, misuse, abuse, or neglect.

For prompt warranty service and special offers, please register your Halex product at our customer service center by visiting our website at: www.regent-halex.com. Enter the following unique registration number followed by the item number of your table found on the cover of this manual: 1ZAK7 _____. You must register your product within 30 days of purchase to be eligible for warranty service. Please make sure to visit our website to order additional parts not covered under the warranty, as well as on-line instruction manuals and new product information. You may also order parts by calling our automated voice recognition system at: 877-516-9707 (Toll Free).

A purchase receipt or other proof of date of purchase will be required before warranty service is performed. Requests for warranty service can be provided by e-mailing the customer service department at cstables@regent-halex.com or by calling customer service at:

877-516-9707 (Toll Free)

10:00 AM to 6:00 PM, EST. (Dec. through Jan.)

10:00 AM to 5:00 PM, EST. (Feb. through Nov.)

Or send request in writing to:

Regent Sports Corporation











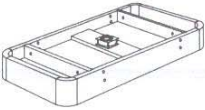
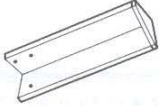
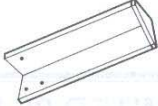
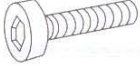
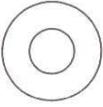

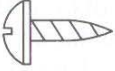
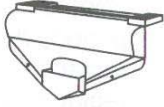
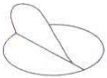
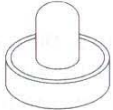
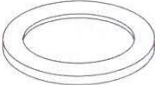

45 Ranick Road

Hauppauge, NY 11788

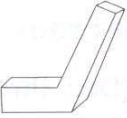
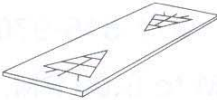
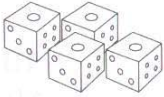
Attn: Halex Customer Service

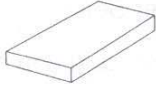
This warranty gives you specific legal rights and you may have other rights that vary from state to state.

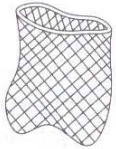
PARTS LIST FOR 50202

<p>#1</p>  <p>Main Frame 1 piece</p>	<p>#2</p>  <p>Left leg 2 pieces</p>	<p>#3</p>  <p>Right leg 2 pieces</p>	<p>#4</p>  <p>Leg bolt 12 pieces</p>
<p>#5</p>  <p>Leg washer 24 pieces</p>	<p>#6</p>  <p>Leg nut 12 pieces</p>	<p>#7</p>  <p>1/2" screw 9 pieces</p>	<p>#8</p>  <p>Goal 2 pieces</p>
<p>#9</p>  <p>Pusher Felt sticker 2 pieces</p>	<p>#10</p>  <p>Pusher 2 pieces</p>	<p>#11</p>  <p>Round Puck 2 pieces</p>	<p>#12</p>  <p>Wrench 1 piece</p>
<p>#13</p>  <p>Bowling pin 1 set</p>	<p>#14</p>  <p>Bowling ball 1 piece</p>	<p>#15</p>  <p>Shuffleboard puck 1 set</p>	<p>#16</p>  <p>Chess Pieces 1 set</p>
<p>#17</p>  <p>Checkers 1 set</p>	<p>#18</p>  <p>Hockey Stick 2 pieces</p>	<p>#19</p>  <p>Game Board 1 piece</p>	<p>#20</p>  <p>Dice 1 set</p>
<p>#21</p>  <p>Dice cup 1 piece</p>	<p>#22</p>  <p>Playing cards 1 set</p>	<p>#23</p>  <p>Accessory bag hook 1 piece</p>	<p>#24</p>  <p>Accessory bag 1 piece</p>
<p>#25</p>  <p>Allen tool 1 piece</p>			

Combination Table Assembly Instructions

Step 1

Place the main frame (#1) face down on a flat, clean surface. Attach the legs (#2) and (#3) to the main frame using leg bolt (#4), leg washer (#5) and leg nut (#6) as shown in the diagram. Screw the accessory bag hook (#23) to an inside edge of the main frame using the screws (#7).

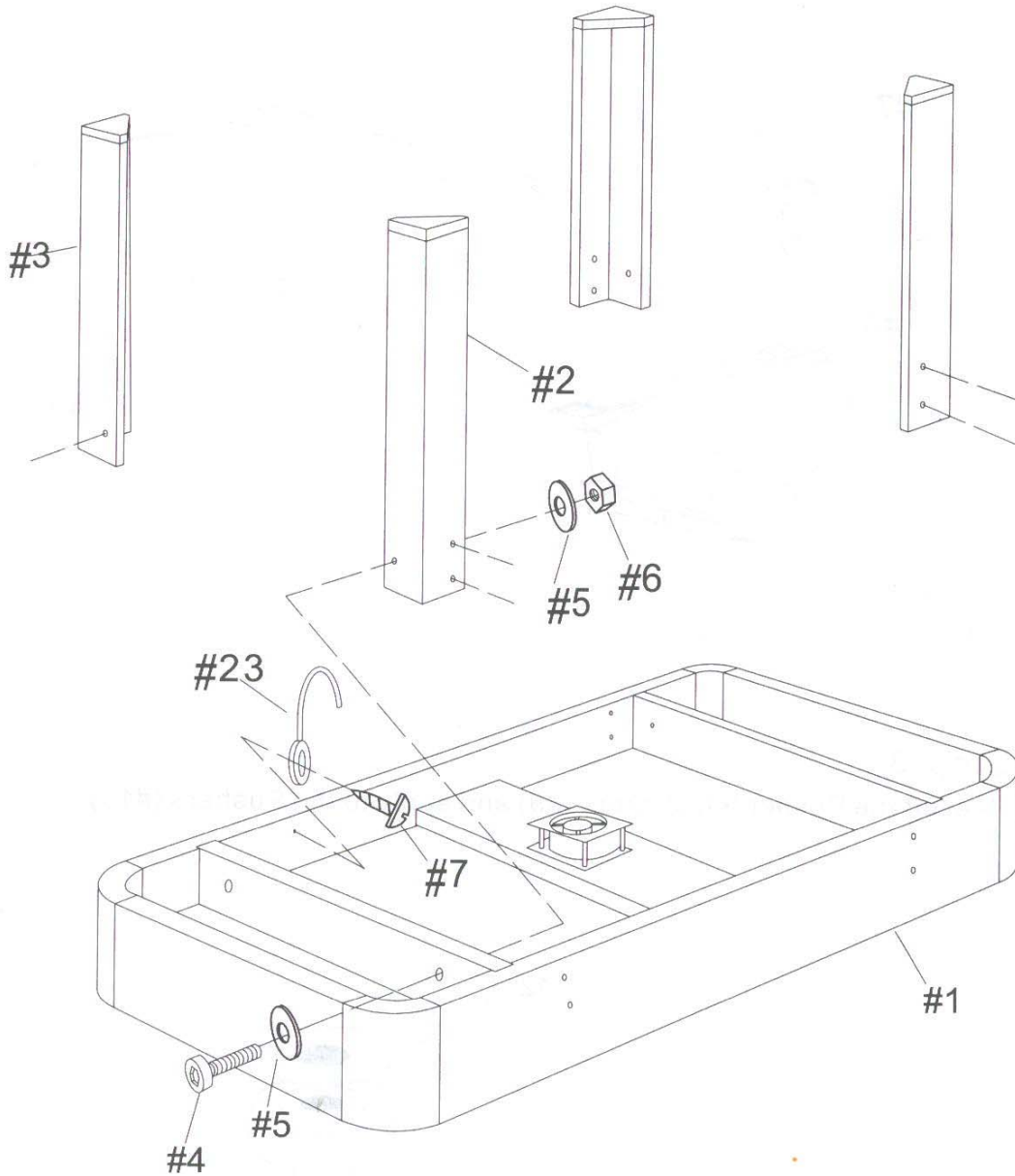

Step 2

Attach the goals (#8) to the end of the top rail of the main frame using the 1/2" screws (#7) as shown.

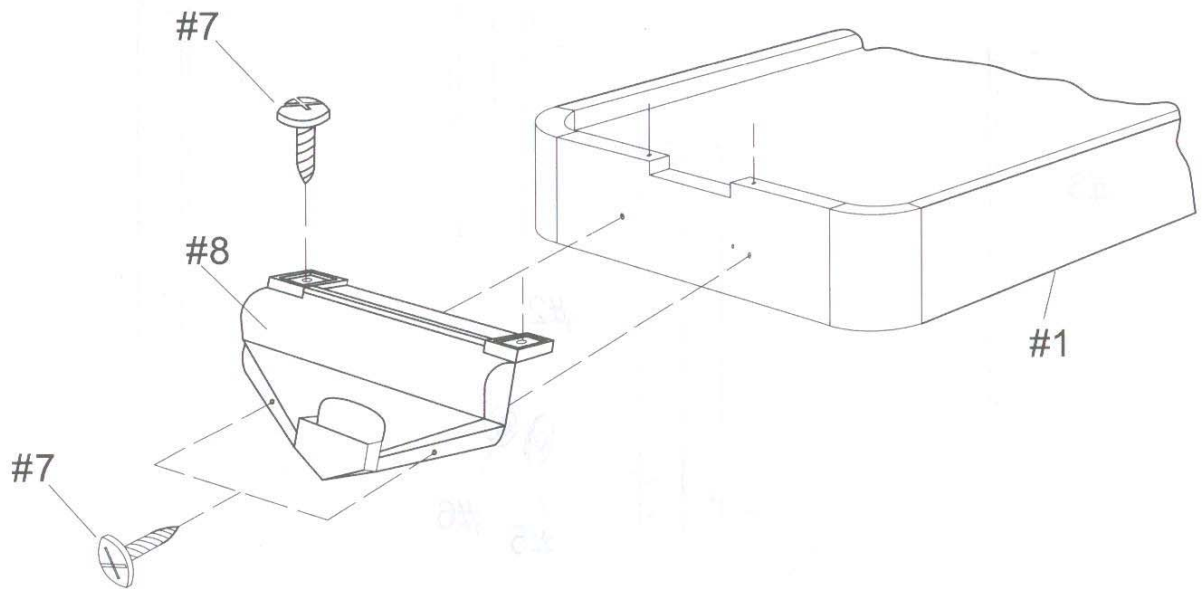

Step 3

Peel off the Pusher felt stickers (#9) and apply to the Pushers (#10).

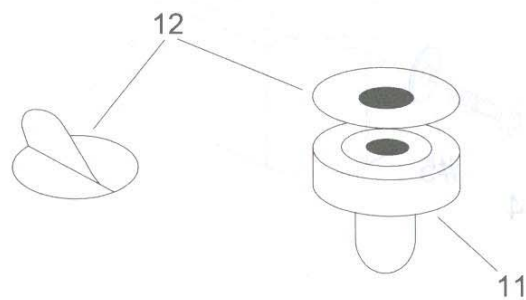

50202

PARTS ORDER FORM

If for some reason you are missing any assembly parts for your Halex game table, please call the Regent Sports Customer Service line at (877) 516-9707 (toll free) between the hours of 10:00am and 5:00 pm EST or go online at www.regent-halex.com for parts ordering. Please refer to the REGENT SPORTS LIMITED WARRANTY concerning missing and defective parts.

Parts also may be ordered by filling out the form below. Please fill in all the information and return to:

REGENT SPORTS CORP.
45 RANICK ROAD
HAUPPAUGE, NEW YORK, 11788
ATTN: CUSTOMER SERVICE

REGENT SPORTS CORP. requires that all orders for replacement parts must be paid by check, money order, VISA, or MC. Cash is not accepted. Please make all checks or money orders payable to REGENT SPORTS CORP. *Please note all prices include shipping and handling.*

Name of Purchaser: _____
Address: _____
City: _____
State: _____ **Zip Code:** _____
Phone: _____

Part #	Description	Quantity	Price	Total Cost
194-50202-2	Left leg	2	\$10.00 EA	
194-50202-3	Right leg	2	\$10.00 EA	
194-50202-4	Leg Bolt	12	\$1.00 EA	
194-50202-5	Leg Washer	24	\$1.00 EA	
194-50202-6	Leg Nut	12	\$1.00 EA	
194-50202-7	1/2" Screw	9	\$1.00 EA	
030-01005SM	Goal	2	\$7.50 EA	
030-01003M	Felt Sticker	2	\$1.00 EA	
030-01001M	Pusher	2	\$3.00 EA	
030-01002M	Round Puck	2	\$1.00 EA	
300-10014	Bowling Pin	10	\$1.00 EA	
300-10015	Bowling Ball	1	\$1.00 EA	
300-10016	Shuffleboard Puck	6	\$1.00 EA	
300-10032	Chess Set	1 Set	\$5.00 EA	
300-10033	Checkers	1 Set	\$5.00 EA	
300-10011	Hockey Stick	2	\$5.00 EA	
300-10010	Gameboard	1	\$10.00 EA	
300-10034	Dice	1 Set	\$2.00 EA	
300-10019	Dice Cup	1	\$2.00 EA	
300-10038	Playing Cards	1 Set	\$5.00 EA	
300-10030	Accessory Bag Hook	1	\$2.00 EA	
300-10018	Accessory Bag	1	\$4.00 EA	

Also be sure to check out our web site at:

www.regent-halex.com

• Parts Ordering • Owners Manual • Product Information

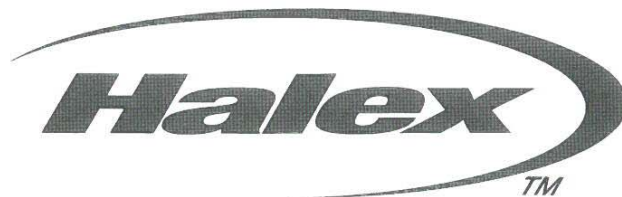

© 2004
Regent Sports Corporation
Hauppauge, New York