

TABLE
Games

Assembly instructions



SPALDING®

50176

CARE AND USE OF YOUR TABLE

WARNING: To reduce the risk of fire, electric shock or injury to persons, use this unit only in the manner intended by the manufacturer. If you have any question, contact the manufacturer. Before servicing or cleaning the unit, switch the power off and unplug the adapter from the wall outlet.

This appliance has a polarized plug (one blade is wider than the other). To reduce the risk of electric shock, this plug is intended to fit in a polarized outlet only one way. If the plug does not fit fully in the outlet, reverse the plug. If it still does not fit, contact a qualified electrician. **DO NOT** attempt to defeat this safety feature.

1. Use spray furniture polish to clean all exterior surfaces of your game table.
2. Use only a suitable 120v AC household outlet.
3. This product is intended for INDOOR use only.
4. DO NOT sit, climb or lean on the table.
5. DO NOT drag the table when moving it. This will damage the leg.
5. The fan should be unplugged before cleaning and servicing.

LIMITED 90 DAY WARRANTY

This Halex product is warranted to be free from defects in workmanship or materials at the time of purchase for a period of 90 (ninety) days. Certain restrictions apply (see below).

Should any evidence of defects appear within the limited warranty period after the date of purchase, Regent Sports will either send replacement parts or advise of another course of action. A list of replaceable parts can be found on the parts order form page of this manual. Parts not listed on this order form are not replaceable. **Table tops, playing surfaces, and main frames are not replaceable.** This warranty covers normal consumer use and does not cover failures, which result from alterations, accidents, misuse, abuse, or neglect.

For prompt warranty service and special offers, please register your Halex product at our customer service center by visiting our website at: www.regent-halex.com. Enter the following unique registration number followed by the item number of your table found on the cover of this manual: 1ZAK7 _____. You can also register your product on our automated voice recognition system at the toll free number below. You must register your product within 30 days of purchase to be eligible for warranty service. Please make sure to visit our website to order additional parts not covered under the warranty, as well as on-line instruction manuals and new product information. You may also order parts by calling our automated voice recognition system.

A purchase receipt or other proof of date of purchase will be required before warranty service is performed. Requests for warranty service can be provided by e-mailing the customer service department at cstables@regent-halex.com or by calling customer service at:

877-516-9707 (Toll Free)

10:00 AM to 6:00 PM, EST. (Dec. through Jan.)







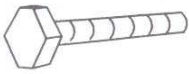
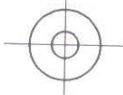
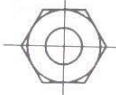
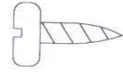
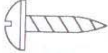
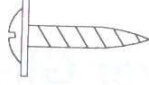
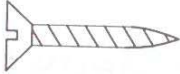
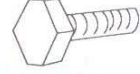

10:00 AM to 5:00 PM, EST. (Feb. through Nov.)

Or send request in writing to:

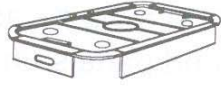
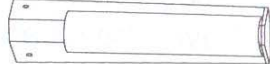
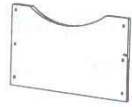

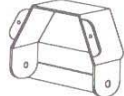

Regent Sports Corporation
45 Ranick Road
Hauppauge, NY 11788
Attn: Halex Customer Service

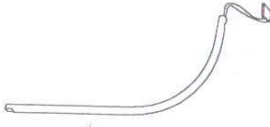
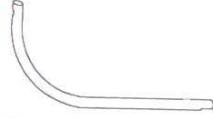
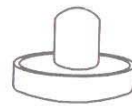
This warranty gives you specific legal rights and you may have other rights that vary from state to state.

Part list for Power Glide Hockey

<p>#1</p>  <p>3/8"X2-1/8" bolt 8 pieces</p>	<p>#2</p>  <p>3/8" washer 16 pieces</p>	<p>#3</p>  <p>3/8" Hex nut 8 pieces</p>	<p>#4</p>  <p>3/8" screw 2 pieces</p>
<p>#5</p>  <p>1/2" screw 24 pieces</p>	<p>#6</p>  <p>1" screw 20 pieces</p>	<p>#7</p>  <p>1-1/2" screw 16 pieces</p>	<p>#8</p>  <p>5/16" X1" bolt 2 pieces</p>
<p>#9</p>  <p>5/16" washer 2 pieces</p>	<p>#10</p>  <p>Main cabinet 1 piece</p>	<p>#11</p>  <p>Leg 4 pieces</p>	<p>#12</p>  <p>Leg end panel 2 pieces</p>
<p>#13</p>  <p>Leg side panel 2 pieces</p>	<p>#14</p>  <p>Apron corner 4 pieces</p>	<p>#15</p>  <p>Panel braces 8 pieces</p>	<p>#16</p>  <p>Puck catcher 2 pieces</p>
<p>#17</p>  <p>Scoreboard pole 1 piece</p>	<p>#18</p>  <p>Steel pole with wire 1 piece</p>	<p>#19</p>  <p>Steel pole without wire 1 piece</p>	<p>#20</p>  <p>Black Pusher 2 pieces</p>

Part list for Power Glide Hockey

#21	#22	#23	#24
			
Pusher felt sticker 2 pieces	Red puck 2 pieces	Blue puck 2 pieces	Wrench 1 piece

Assembly Steps for Power Glide Hockey

Step 1

Place the main frame of the hockey table face down on a clean, flat surface. Fold out the side and end panels of the table and secure using the panel braces #15 and 1-1/2" screws #7 as shown. Slide the apron corners #14 over the side and end panels and secure using the 1/2" screws #5.

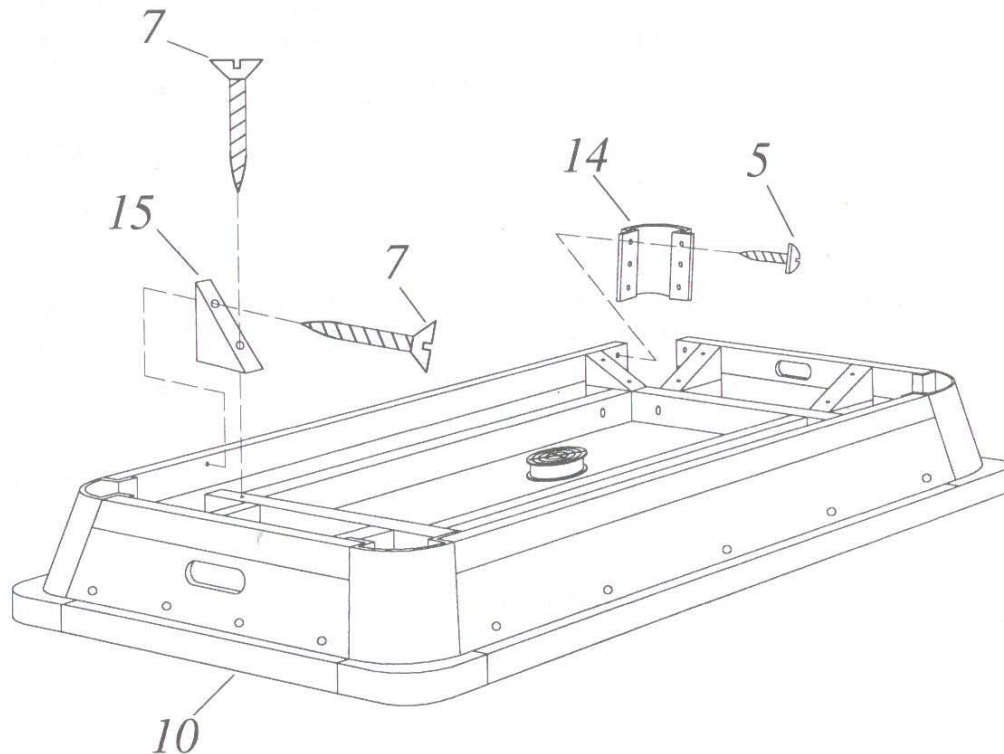

Step 2

Attach the legs #11 to the main frame using the 2-1/8" bolts #1, 3/8" washers #2, and hex nuts #3. Attach the leg end panels #12 to each set of legs using the 1" screws #6.

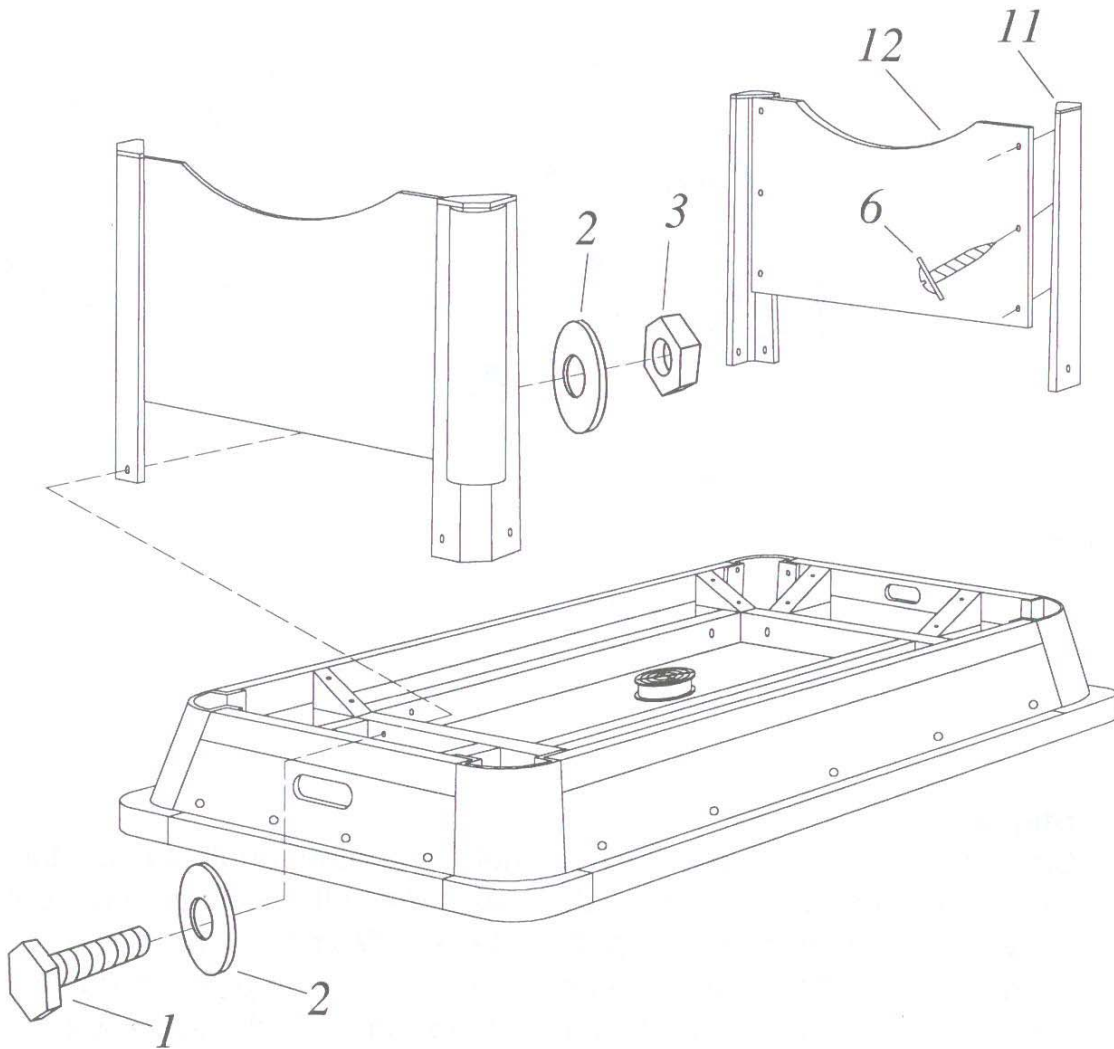

Step 3

Attach the leg side panels #13 to the legs using the 1" screws #6. Attach the puck catchers #16 over each goal opening inside the table using the 1/2" screws #5.

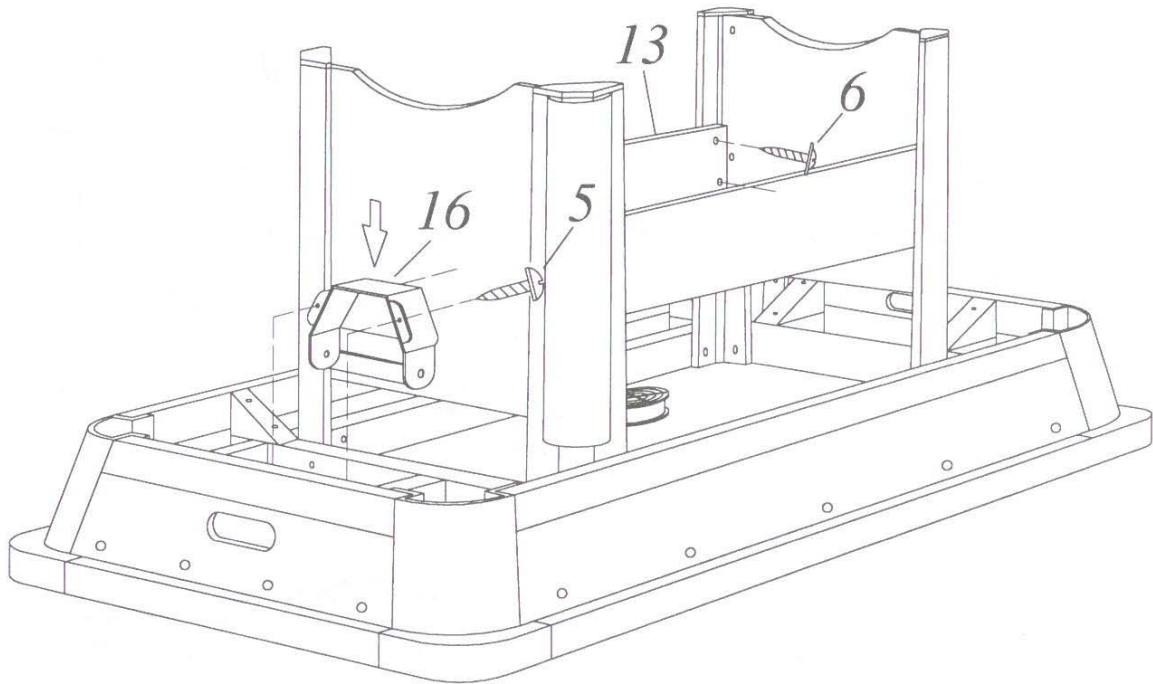

Step 4

Carefully flip the table over with the help of another adult. Locate the electronic scoring wiring under the table. Place the steel pole without the wire #19 in the hole on top of the table **AWAY** from the electronic scoring wiring. Attach the coreboard pole #17 to the pole without the wire using the 3/8" screw #4. Connect the wire from the scoreboard pole to the steel pole with the wire #18. Attach these two poles with 3/8" screw #4. Place the steel pole with the wire in the remaining hole on top of the table. Connect the wires from under the table to the wires from this pole as shown. Once connected, tighten the pole to the table using the 5/16" bolt #8 and 5/16" washer #9.

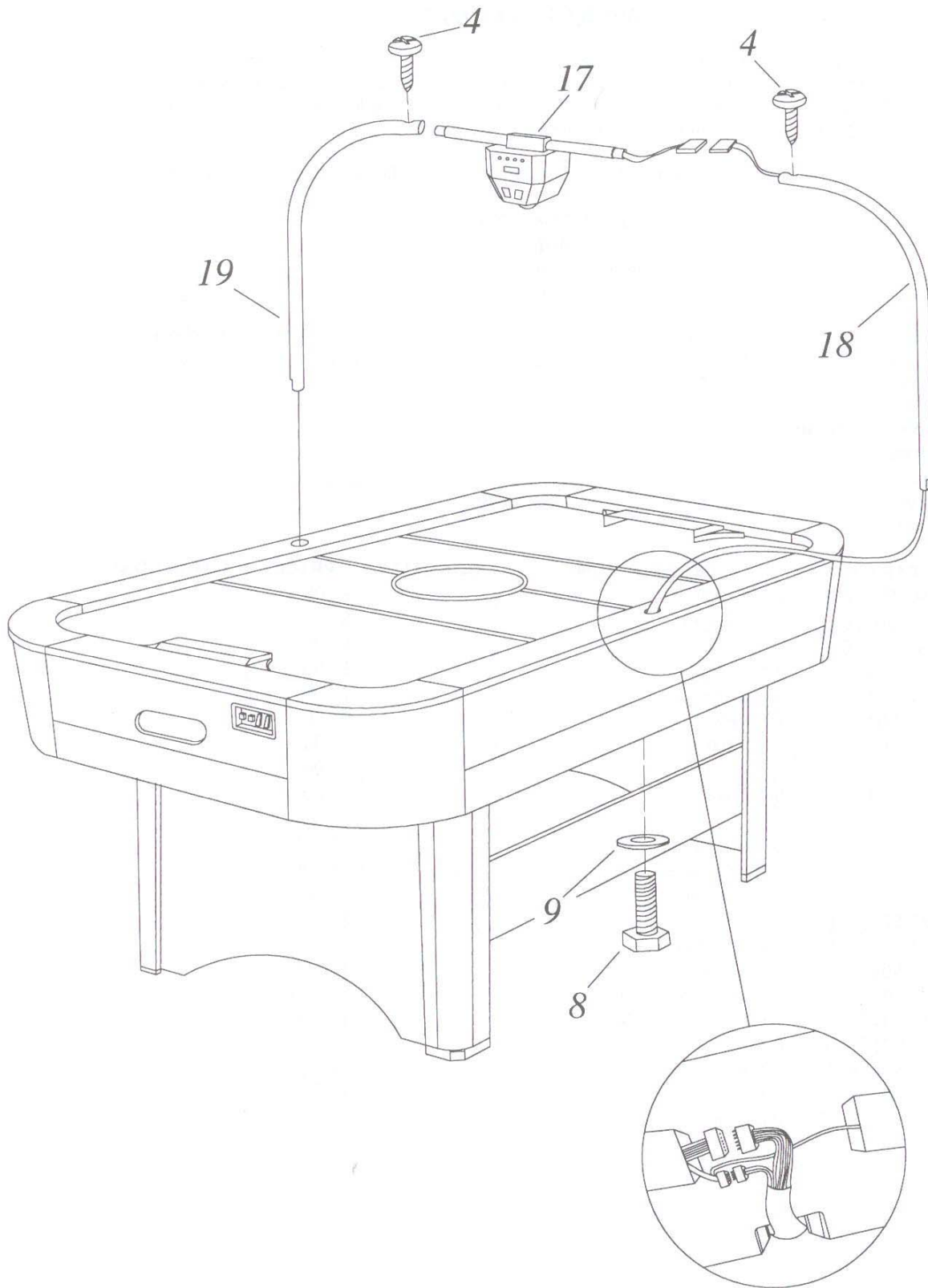

PARTS ORDER FORM

If for some reason you are missing any assembly parts for your Halex game table, please call the Regent Sports Customer Service line at (877) 516-9707 (toll free) between the hours of 10:00am and 5:00pm EST or go online at www.regent-halex.com for parts ordering. Please refer to the REGENT SPORTS LIMITED WARRANTY concerning missing and defective parts.

Parts also may be ordered by filling out the form below. Please fill in all the information and return to:

REGENT SPORTS CORP.
45 RANICK ROAD
HAUPPAUGE, NEW YORK, 11788
ATTN: CUSTOMER SERVICE

REGENT SPORTS CORP. requires that all orders for replacement parts must be paid by check, money order, VISA, or MC. Cash is not accepted. Please make all checks or money orders payable to REGENT SPORTS CORP. *Please note all prices include shipping and handling.*

Name of Purchaser: _____
Address: _____
City: _____
State: _____ **Zip Code:** _____
Phone: _____

PART #	DESCRIPTION	QUANTITY	PRICE	TOTAL COST
192-50176-1	2 1/8" bolt		\$1.00	
192-50176-2	3/8" washer		\$1.00	
192-50176-3	Hex nut		\$1.00	
192-50176-4	3/8" screw		\$1.00	
192-50176-5	1/2" screw		\$1.00	
192-50176-6	1" screw		\$1.00	
192-50176-7	1 1/2" screw		\$1.00	
192-50176-8	5/16" bolt		\$1.00	
192-50176-9	5/16" washer		\$1.00	
192-50176-11	Leg		\$17.50	
192-50176-12	Leg end panel		\$12.50	
192-50176-13	Leg side panel		\$15.00	
192-50176-14	Apron corner		\$5.00	
192-50176-15	Panel braces		\$2.50	
192-50176-16	Puck catcher		\$7.50	
192-50176-17	Scoreboard pole		\$20.00	
192-50176-18	Steel pole with wire		\$12.00	
192-50176-19	Steel pole without wire		\$10.00	
192-50176-20	Pusher		\$5.00	
192-50176-21	Pusher felt sticker		\$2.00	
192-50176-22	Red puck		\$2.00	
192-50176-23	Blue puck		\$2.00	

Also be sure to check out our web site at:

www.regent-halex.com

• Parts Ordering • Owners Manual • Product Information



© 2004
Regent Sports Corporation
Hauppauge, New York