

TABLE

# Games

*Assembly instructions*

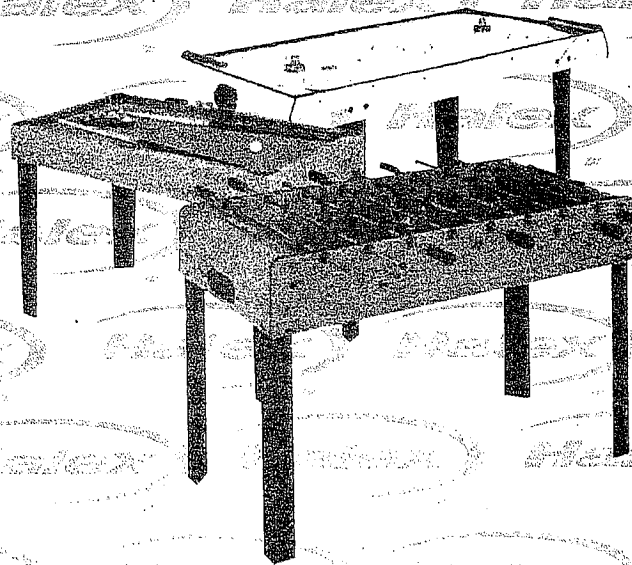

**Halex**

TM

50174

**PLEASE DO NOT RETURN THIS ITEM TO THE STORE!**

**Should you have a defect or parts issue, please refer to the warranty instructions listed below and contact Regent Sports at our toll free number!!**

**LIMITED 90 DAY WARRANTY**

This Halex product is warranted to be free from defects in workmanship or materials at the time of purchase for a period of 90 (ninety) days. Certain restrictions apply (see below).

Should any evidence of defects appear within the limited warranty period after the date of purchase, Regent Sports will either send replacement parts or advise of another course of action. A list of replaceable parts can be found on the parts order form page of this manual. Parts not listed on this order form are not replaceable. **Table tops, playing surfaces, and main frames are not replaceable.** This warranty covers normal consumer use and does not cover failures, which result from alterations, accidents, misuse, abuse, or neglect.

For prompt warranty service and special offers, please register your Halex product at our customer service center by visiting our website at: [www.regent-halex.com](http://www.regent-halex.com). Enter the following unique registration number followed by the item number of your table found on the cover of this manual: 1ZAK7 \_\_\_\_\_. You must register your product within 30 days of purchase to be eligible for warranty service. Please make sure to visit our website to order additional parts not covered under the warranty, as well as on-line instruction manuals and new product information. You may also order parts by calling our automated voice recognition system (877) 516-8707.

A purchase receipt or other proof of date of purchase will be required before warranty service is performed. Requests for warranty service can be provided by e-mailing the customer service department at [cstables@regent-halex.com](mailto:cstables@regent-halex.com) or by calling customer service at:

**877-516-9707 (Toll Free)**

**10:00 AM to 6:00 PM, EST. (Dec. through Jan.)**











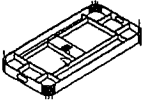





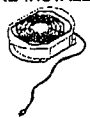

**10:00 AM to 5:00 PM, EST. (Feb. through Nov.)**

Or send request in writing to:

**Regent Sports Corporation  
45 Ranick Road  
Hauppauge, NY 11788  
Attn: Halex Customer Service**

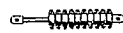
This warranty gives you specific legal rights and you may have other rights that vary from state to state.

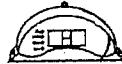
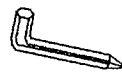
# AIR HOCKEY 50174 PARTS LIST

<p>① (197-50174-01)</p>  <p>CABINET ASSEMBLY 2EA</p>	<p>② (197-50174-02)</p>  <p>RIGHT LEG 2EA</p>	<p>③ (197-50174-03)</p>  <p>LEFT LEG 2EA</p>	<p>④ (197-50174-04)</p>  <p>LEG PANEL 2EA</p>	<p>⑤ (197-50174-05)</p>  <p>22MM FLAT WASHER 12EA</p>	<p>⑥ (197-50174-06)</p>  <p>8X30MM ALLEN KEY LEG BOLT 12EA</p>
<p>⑦ (197-50174-07)</p>  <p>PUCK RETURN UNIT 2EA</p>	<p>⑧ (197-50174-08)</p>  <p>LEG LEVELER 4 EA</p>	<p>⑨ (197-50174-09) PRE-INSTALLED</p>  <p>HOCKEY MOTOR 1EA</p>	<p>⑩ (197-50174-10)</p>  <p>3.5X12MM WASHER HEAD SCREW 4EA</p>	<p>⑪ (197-50174-11)</p>  <p>PUSHER 2EA</p>	<p>⑫ (197-50174-12)</p>  <p>PUCK-RED 2EA</p>
<p>⑬ (197-50174-13)</p>  <p>PUCK-YELLOW 2EA</p>	<p>⑭ (197-50174-14)</p>  <p>4X25MM WASHER HEAD BOLT 8EA</p>	<p>⑮ (197-50174-15)</p>  <p>SLIDE SCORER 2EA</p>	<p>⑯ (197-50174-16)</p>  <p>3.5X25MM FLAT HEAD SCREW 6EA</p>	<p>⑰ (197-50174-17)</p>  <p>LCD SCORER 1EA</p>	<p>⑱ (197-50174-18)</p>  <p>ALLEN KEY 1EA</p>
<p>⑲ (197-50174-19) PRE-INSTALLED</p>  <p>NAME PLATE 2EA</p>	<p>Step 1- Attach legs #3 and # 2 to the main frame of the cabinet using bolts #6 and washers #5. Next attach end panels #4 using bolts #14. Attach puck return units #7 using screws #10. Screw in leg levelers #8 into each leg.</p>				

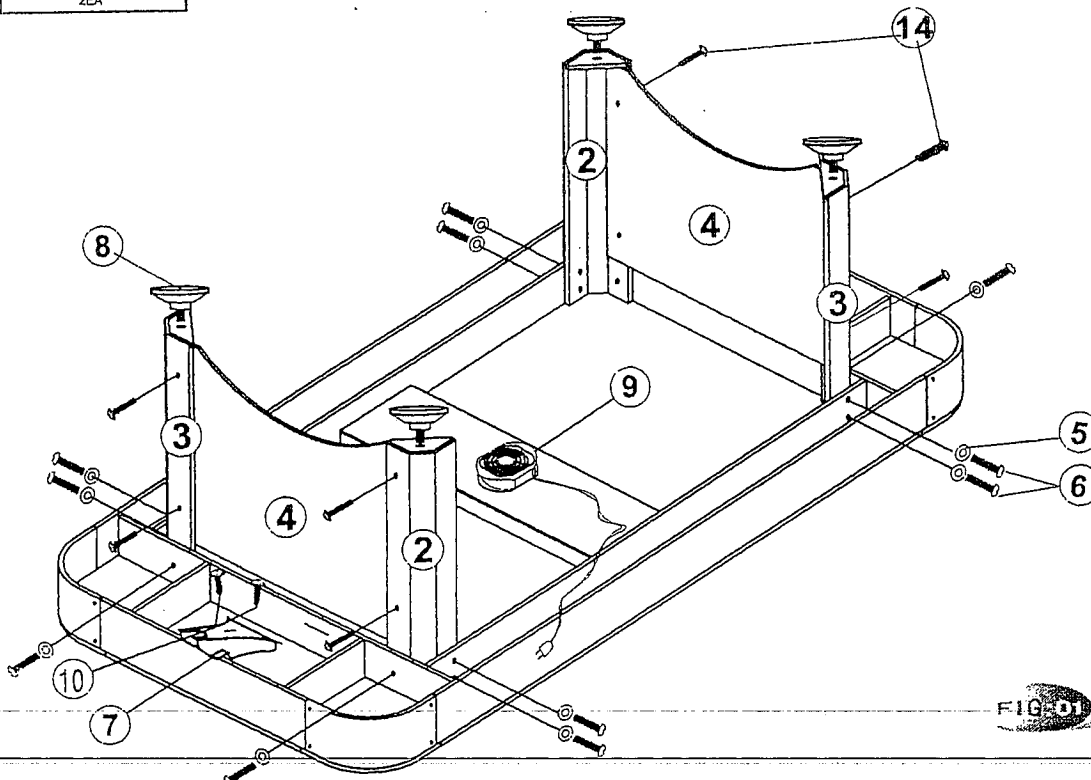
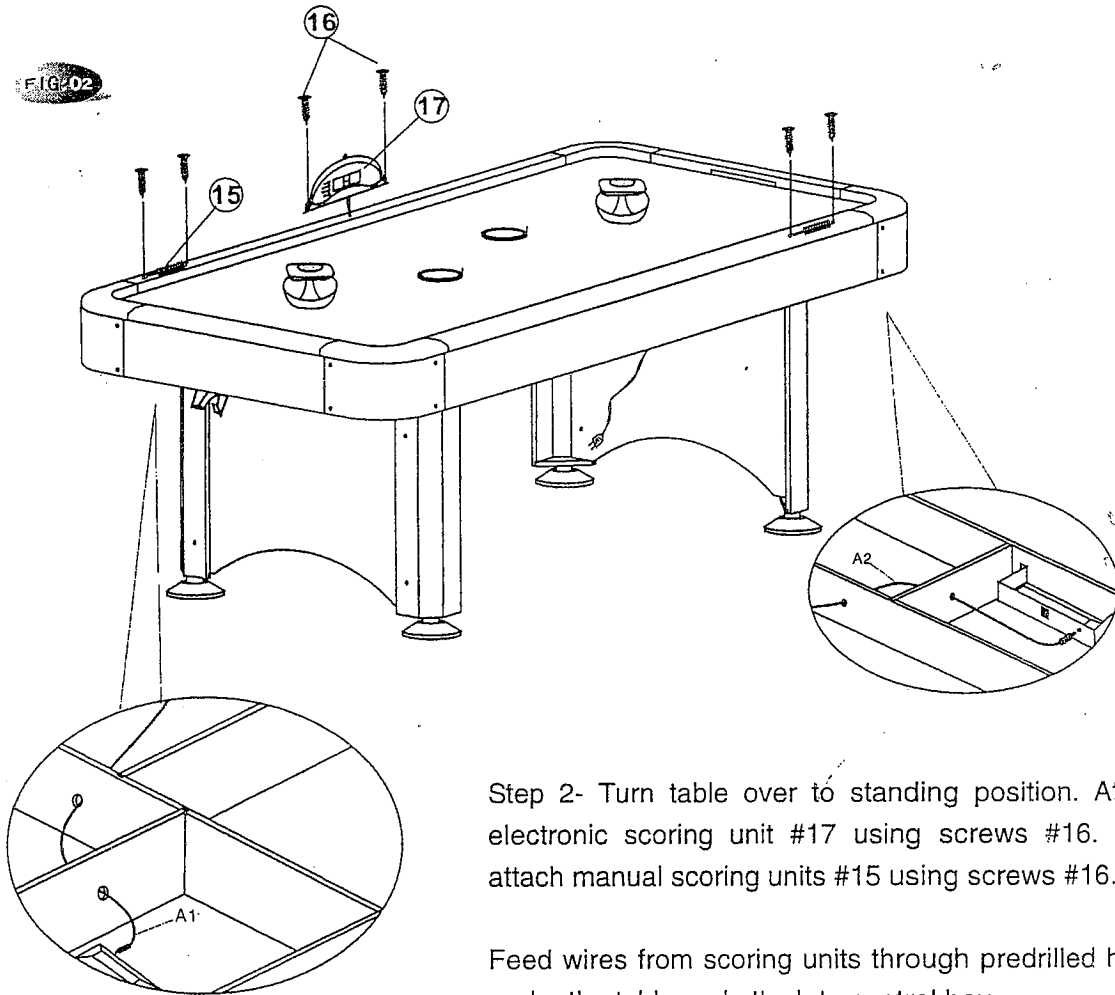

FIG. 02



Step 2- Turn table over to standing position. Attach electronic scoring unit #17 using screws #16. Next attach manual scoring units #15 using screws #16.

Feed wires from scoring units through predrilled holes under the table and attach to control box.



**Also be sure to check out our web site at:**

**[WWW.regent-halex.com](http://WWW.regent-halex.com)**

• Parts Ordering • Owners Manual • Product Information



© 2007  
Regent Sports Corporation  
Hauppauge, New York