

TABLE

Games

Assembly instructions



Halex
TM

50166

CARE AND USE OF YOUR TABLE

WARNING: To reduce the risk of fire, electric shock or injury to persons, use this unit only in the manner intended by the manufacturer. If you have any question, contact the manufacturer. Before servicing or cleaning the unit, switch the power off and unplug the adapter from the wall outlet.

This appliance has a polarized plug (one blade is wider than the other). To reduce the risk of electric shock, this plug is intended to fit in a polarized outlet only one way. If the plug does not fit fully in the outlet, reverse the plug. If it still does not fit, contact a qualified electrician. **DO NOT** attempt to defeat this safety feature.

1. Use spray furniture polish to clean all exterior surfaces of your game table.
2. Use only a suitable 120v AC household outlet.
3. This product is intended for INDOOR use only.
4. **DO NOT** sit, climb or lean on the table.
5. **DO NOT** drag the table when moving it. This will damage the leg.
6. The fan should be unplugged before cleaning and servicing.



LIMITED 90 DAY WARRANTY

This Halex product is warranted to be free from defects in workmanship or materials at the time of purchase for a period of 90 (ninety) days. Certain restrictions apply (see below).

Should any evidence of defects appear within the limited warranty period after the date of purchase, Regent Sports will either send replacement parts or advise of another course of action. A list of replaceable parts can be found on the parts order form page of this manual. Parts not listed on this order form are not replaceable. **Table tops, playing surfaces, and main frames are not replaceable.** This warranty covers normal consumer use and does not cover failures, which result from alterations, accidents, misuse, abuse, or neglect.

For prompt warranty service and special offers, please register your Halex product at our customer service center by visiting our website at: www.regent-halex.com. Enter the following unique registration number followed by the item number of your table found on the cover of this manual: 1ZAK7 _____. You must register your product within 30 days of purchase to be eligible for warranty service. Please make sure to visit our website to order additional parts not covered under the warranty, as well as on-line instruction manuals and new product information. You may also order parts by calling our automated voice recognition system at: 877-516-9707 (Toll Free).

A purchase receipt or other proof of date of purchase will be required before warranty service is performed. Requests for warranty service can be provided by e-mailing the customer service department at cstables@regent-halex.com or by calling customer service at:

877-516-9707 (Toll Free)

10:00 AM to 6:00 PM, EST. (Dec. through Jan.)









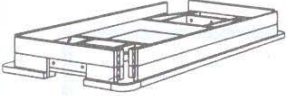
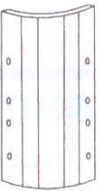
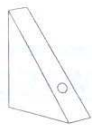
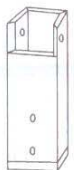
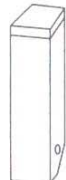
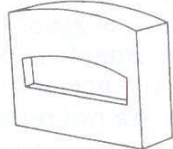
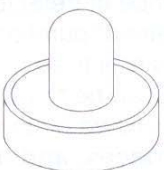

10:00 AM to 5:00 PM, EST. (Feb. through Nov.)

Or send request in writing to:

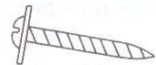
Regent Sports Corporation
45 Ranick Road
Hauppauge, NY 11788
Attn: Halex Customer Service

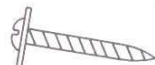
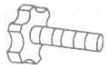
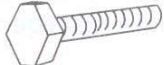
This warranty gives you specific legal rights and you may have other rights that vary from state to state.

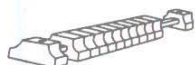
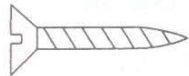
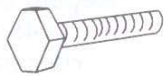
50166 Parts List

<p>#1</p>  <p>Main Frame 1 piece</p>	<p>#2</p>  <p>Apron Corner 4 Pieces</p>	<p>#3</p>  <p>Panel Braces 8 Pieces</p>	<p>#4</p>  <p>Leg A 4 pieces</p>
<p>#5</p>  <p>Leg B 4 pieces</p>	<p>#6</p>  <p>Puck Catcher 2 pieces</p>	<p>#7</p>  <p>Pusher 2 pieces</p>	<p>#8</p>  <p>Pusher Felt Sticker 2 pieces</p>
<p>#9</p>  <p>Puck 4 pieces</p>	<p>#10</p>  <p>Slap Hockey Stick 3 pieces</p>	<p>#11</p>  <p>1" Screw 32 pieces</p>	<p>#12</p>  <p>1-1/2" Flat Head Screw 8 pieces</p>
<p>#13</p>  <p>1-1/4" Screw 8 pieces</p>	<p>#14</p>  <p>1-1/8" Hand Bolt 8 Pieces</p>	<p>#15</p>  <p>3/8" Bolt 8 pieces</p>	<p>#16</p>  <p>3/8" Washer 8 pieces</p>
<p>#17</p>  <p>Slide Scorer 2 pieces</p>	<p>#18</p>  <p>1" Flat Head Screw 4 pieces</p>	<p>#19</p>  <p>1/4"X1" Bolt 4 pieces</p>	<p>#20</p>  <p>1/4" Washer 4 pieces</p>
<p>#21</p>  <p>Wrench 1 piece</p>			

50166 assembly instructions

Step 1 Lay the main frame face (1) down on a clean, flat surface. Unfold the main frame side panels and slide the apron corners (2) into each corner as shown in the diagram. Secure with the 1" screws (11). Place the panel braces (3) into place and secure on the inside of the main frame with the 1-1/2" flat head screws (12), and secure through the outside with the 1-1/4" screws (13).

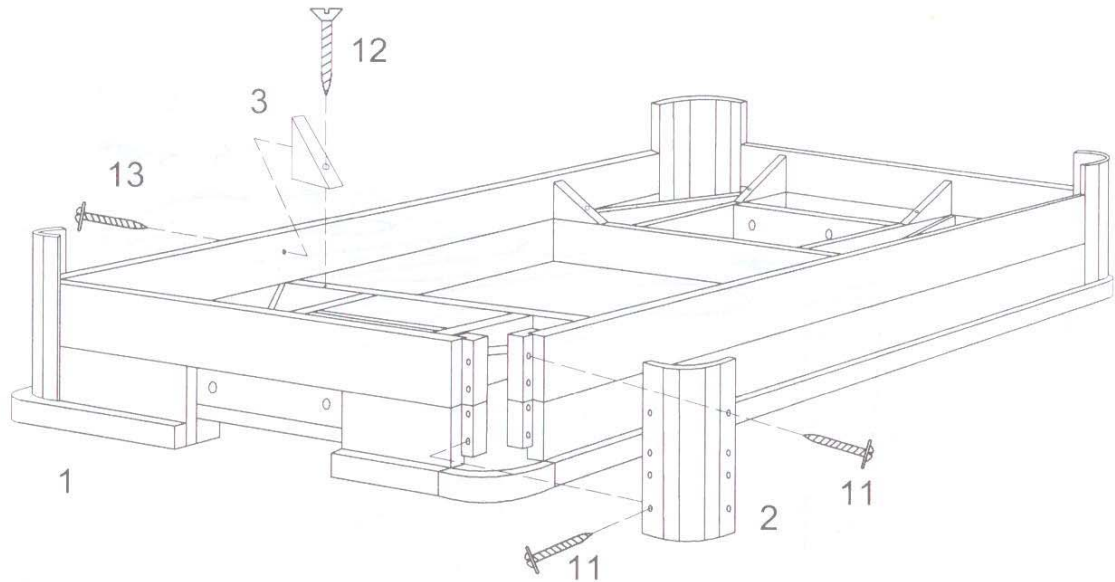

Step 2 Place the Leg A piece (4) into each corner of the main frame with the open end facing up. Secure by screwing the 3/8" bolt (15) and 3/8" washer (16) into the pre-drilled holes in the main frame and leg A. Place the Leg B piece (5) into the Leg A (4) and secure by inserting the 1-1/8" hand bolts (14) through the outside.

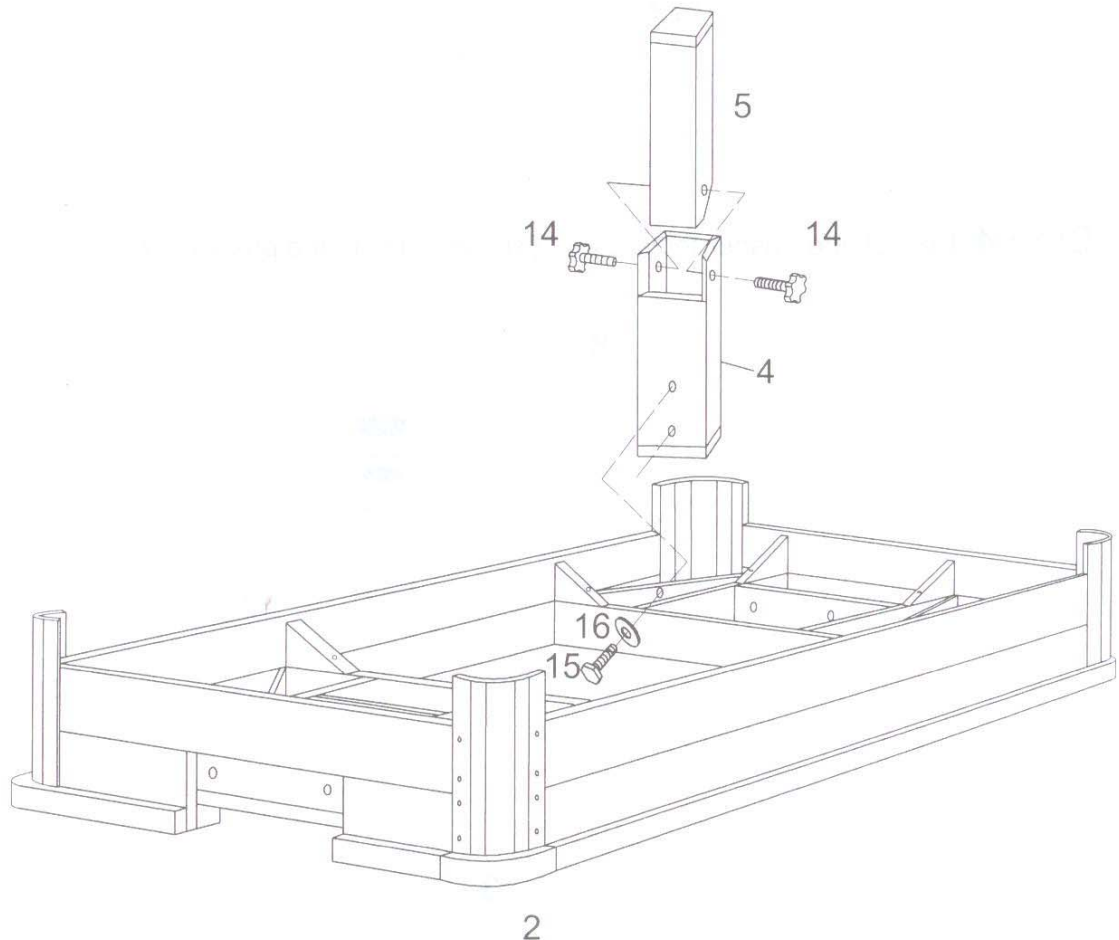

Step 3 Place the puck catcher (6) into the end panel of the main frame as depicted in the diagram. Secure by screwing the 1/4" bolt (19) and 1/4" washer (20) through the underside of the main frame. Affix the slide scorer (17) to the rail of the main frame using the 1" flat head screws (18).

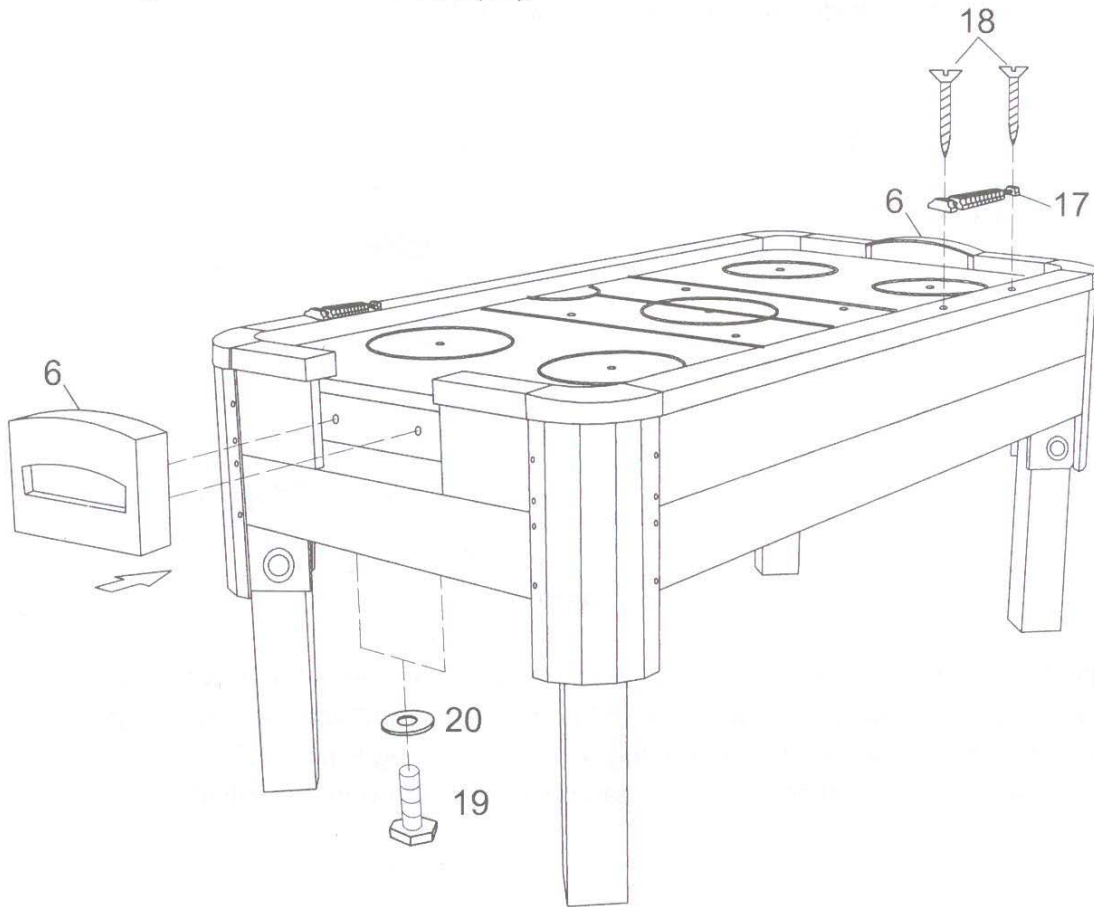

Step 4 Peel off the pusher felt stickers (8) and apply to the pushers (7).

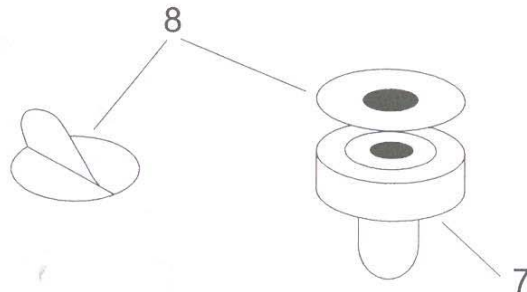

PARTS ORDER FORM

If for some reason you are missing any assembly parts for your Halex game table, please call the Regent Sports Customer Service line at (877) 516-9707 (toll free) between the hours of 10:00am and 5:00 pm EST or go online at www.regent-halex.com for parts ordering. Please refer to the REGENT SPORTS LIMITED WARRANTY concerning missing and defective parts.

Parts also may be ordered by filling out the form below. Please fill in all the information and return to:

REGENT SPORTS CORP.
45 RANICK ROAD
HAUPPAUGE, NEW YORK, 11788
ATTN: CUSTOMER SERVICE

REGENT SPORTS CORP. requires that all orders for replacement parts must be paid by check, money order, VISA, or MC. Cash is not accepted. Please make all checks or money orders payable to REGENT SPORTS CORP. *Please note all prices include shipping and handling.*

Name of Purchaser: _____

Address: _____

City: _____

State: _____ Zip Code: _____

Phone: _____

Part #	Description	Quantity	Price	Total Cost
194-50166-2	apron corner		\$7.50	
194-50166-3	panel braces		\$2.00	
194-50166-4	leg A		\$10.00	
194-50166-5	leg B		\$7.50	
194-50166-6	puck catcher		\$5.00	
194-50166-7	pusher		\$3.00	
194-50166-8	pusher felt sticker		\$1.00	
194-50166-9	puck		\$1.00	
194-50166-10	slap hockey stick		\$3.00	
194-50166-11	1" screw		\$1.00	
194-50166-12	1 1/2" flat head screw		\$1.00	
194-50166-13	1 1/4" screw		\$1.00	
194-50166-14	1 1/8" hand bolt		\$1.00	
194-50166-15	3/8" bolt		\$1.00	
194-50166-16	3/8" washer		\$5.00	
194-50166-17	slide scorer		\$5.00	
194-50166-18	1" flat head screw		\$1.00	
194-50166-19	1/4" bolt		\$1.00	
194-50166-20	1/4" washer		\$1.00	

Also be sure to check out our web site at:

www.regent-halex.com

• Parts Ordering • Owners Manual • Product Information



© 2004
Regent Sports Corporation
Hauppauge, New York